

智控电子秤

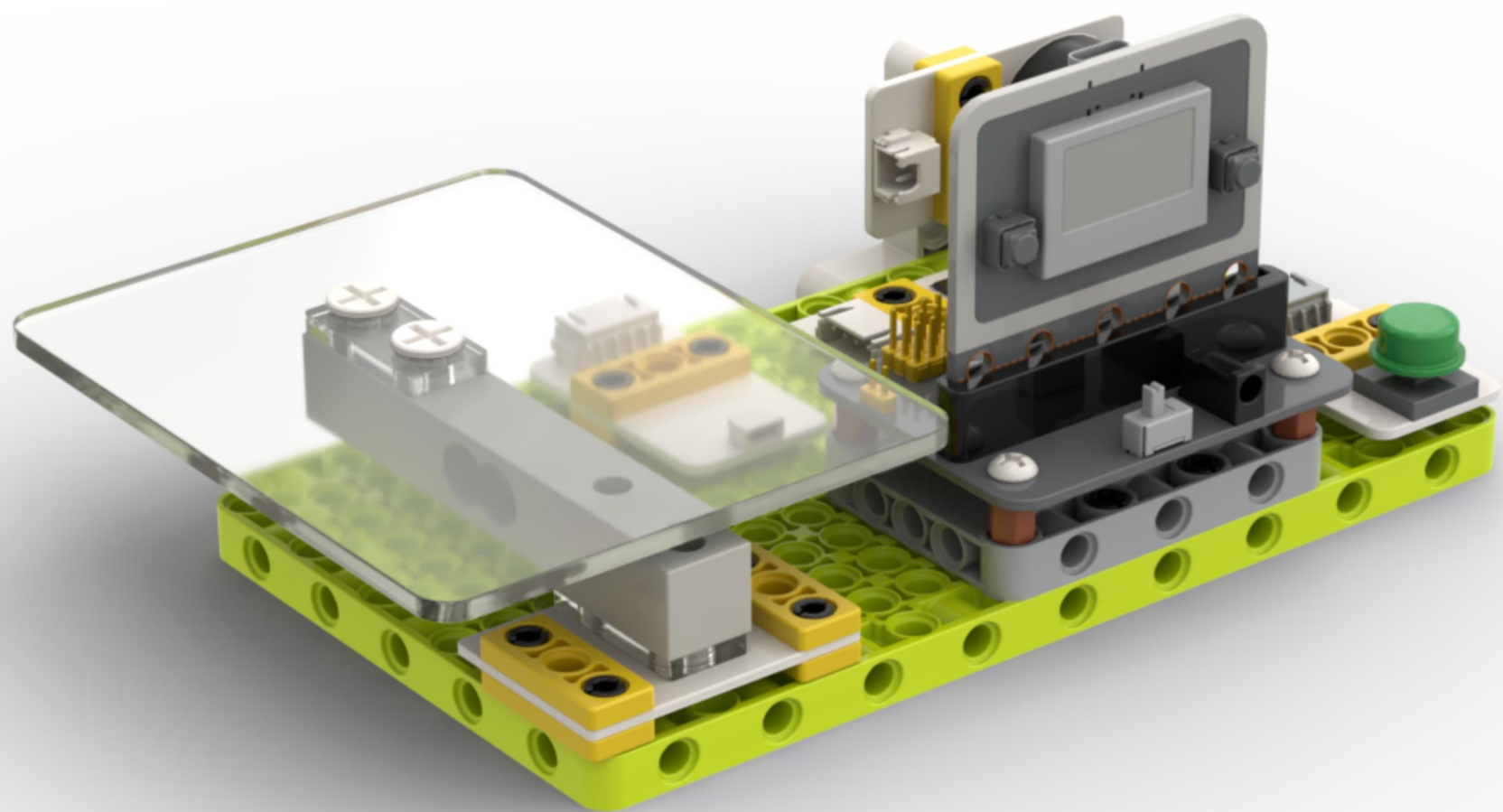

1

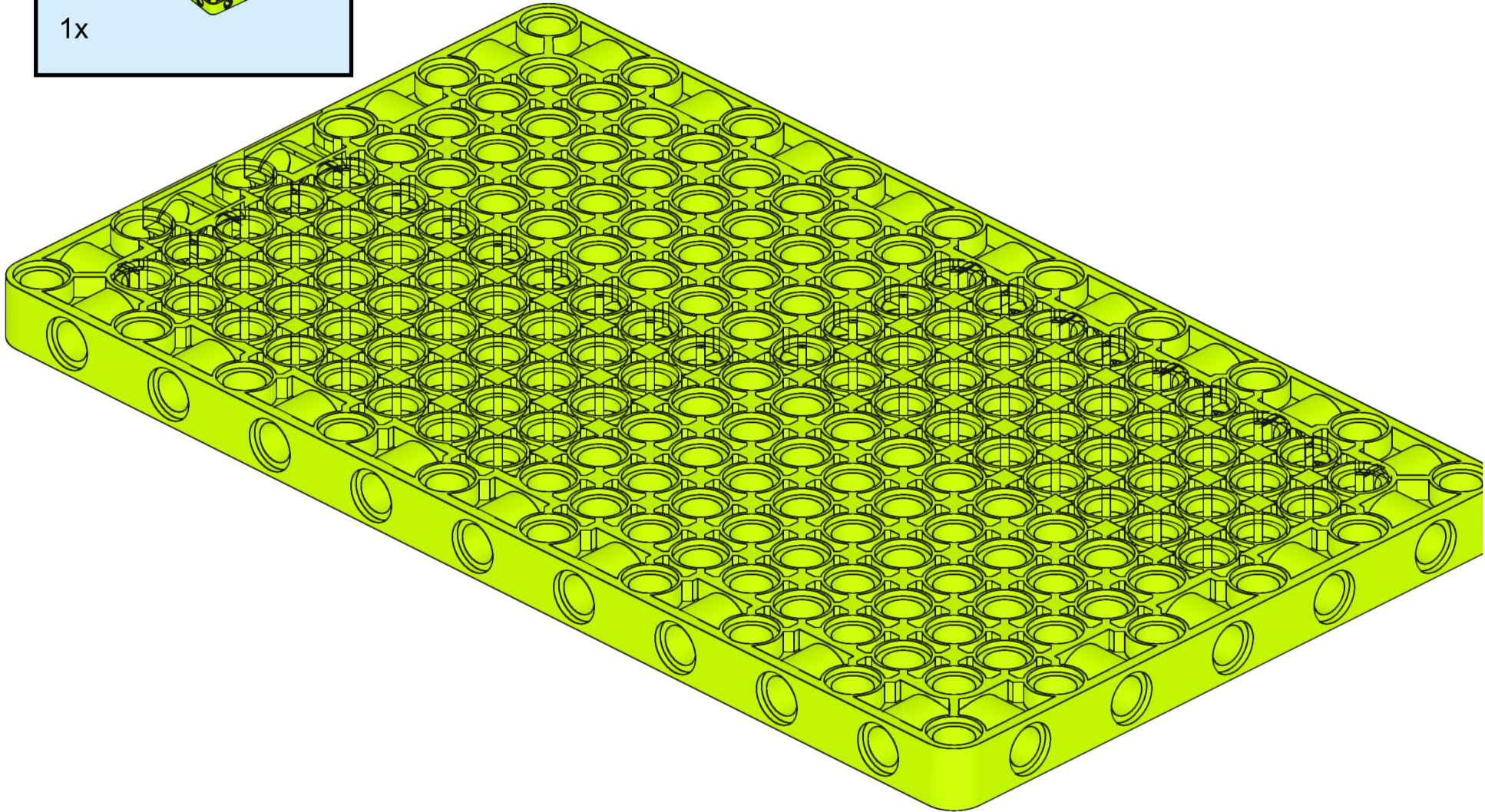
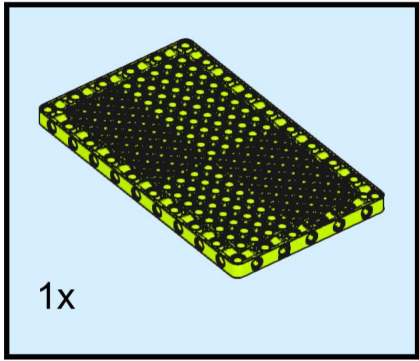

2

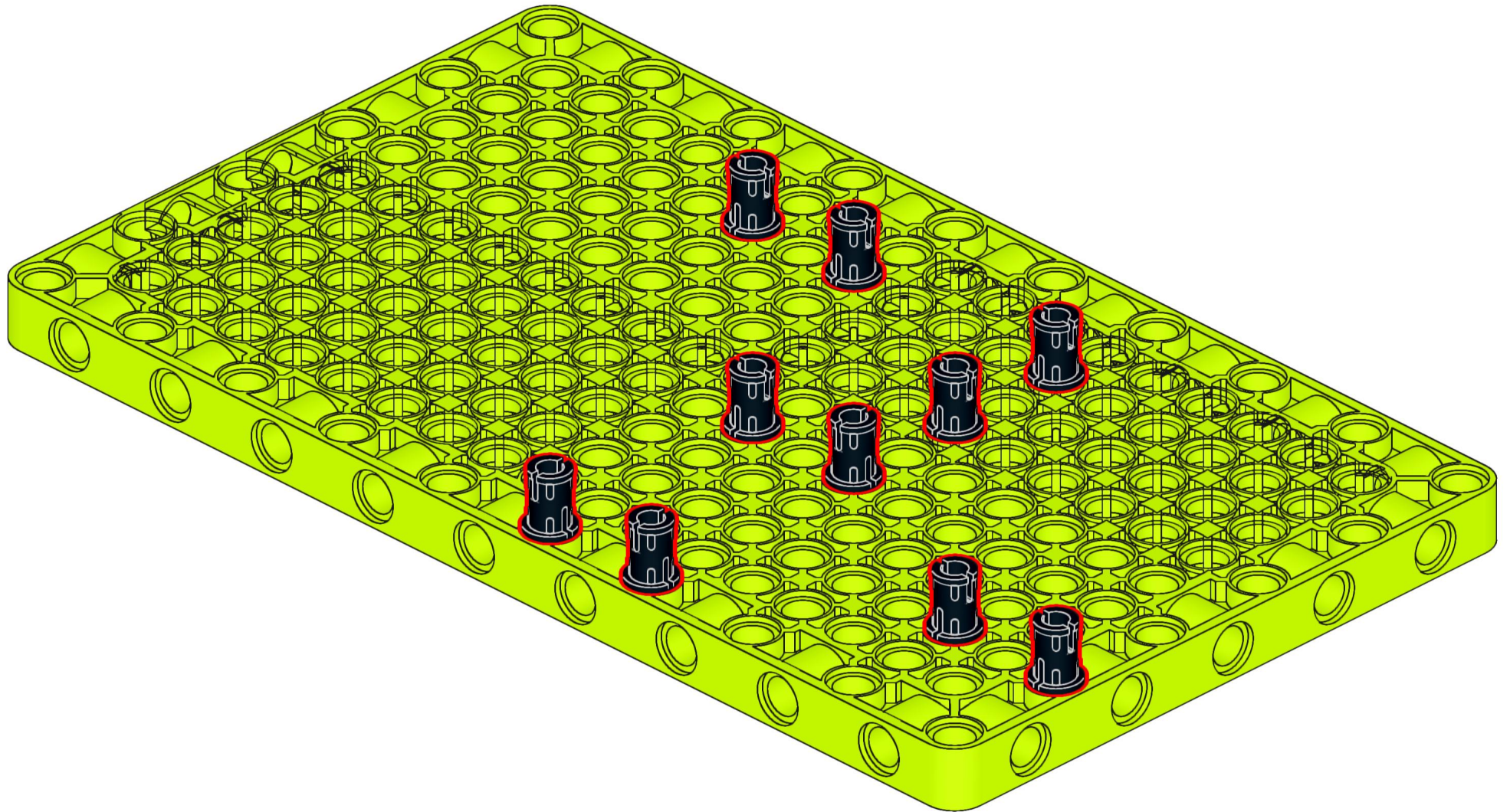

3

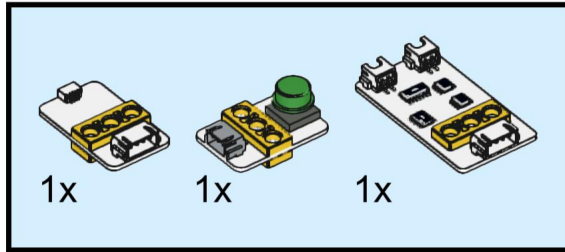

称重转接模块 按钮模块 语音合成模块

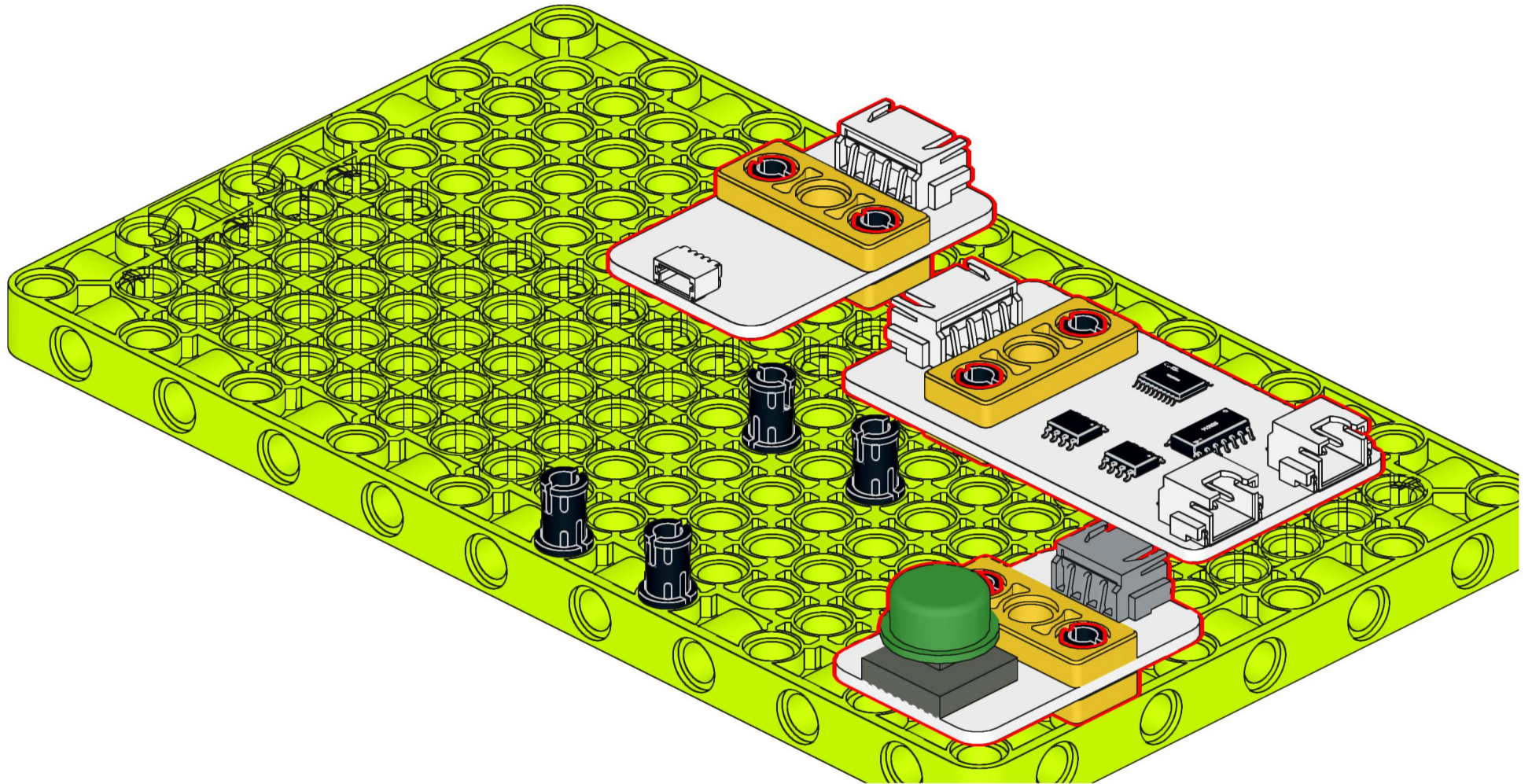

4

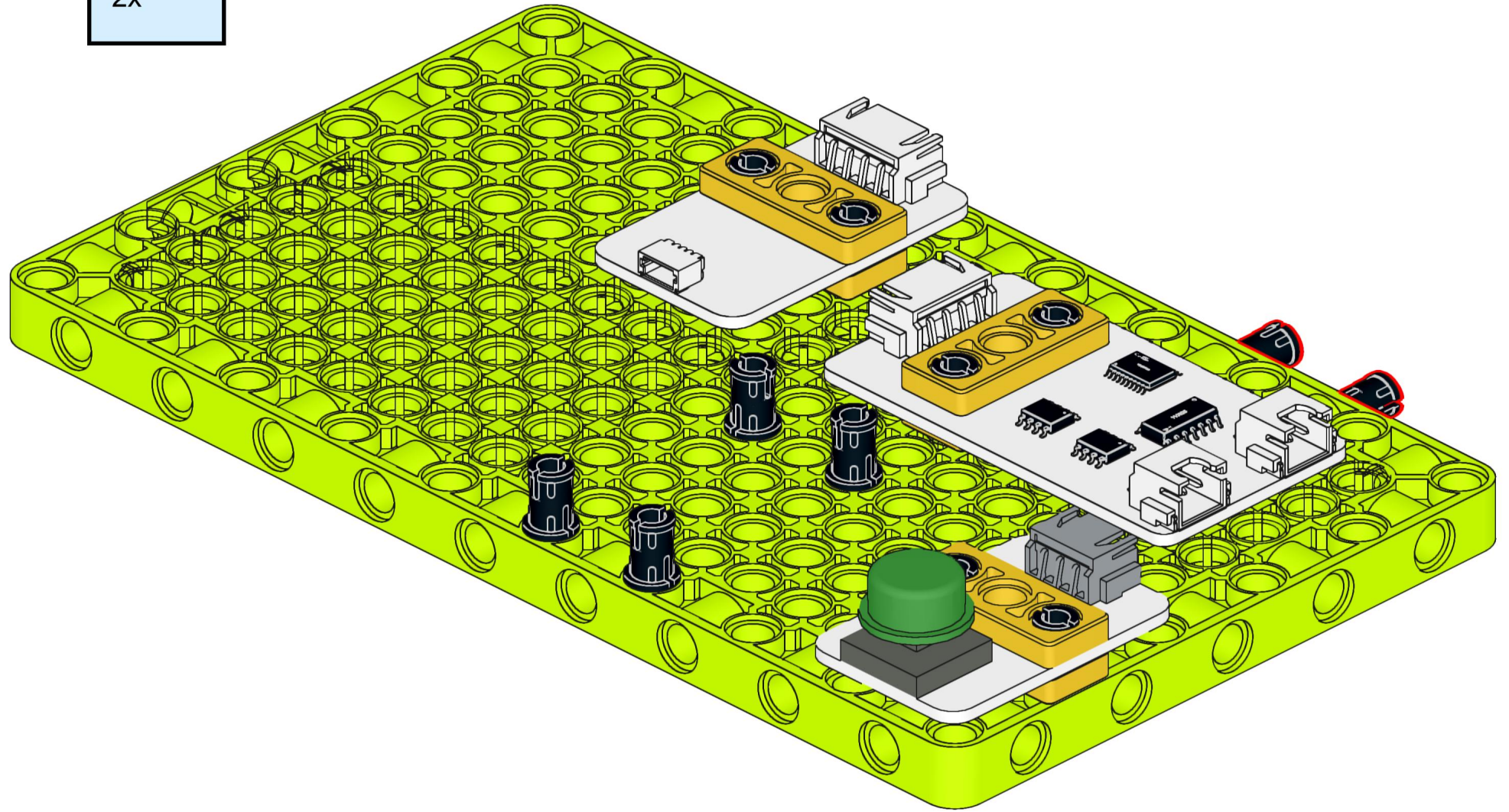

5

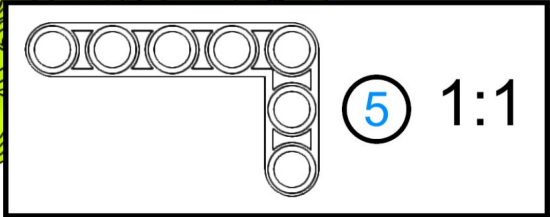
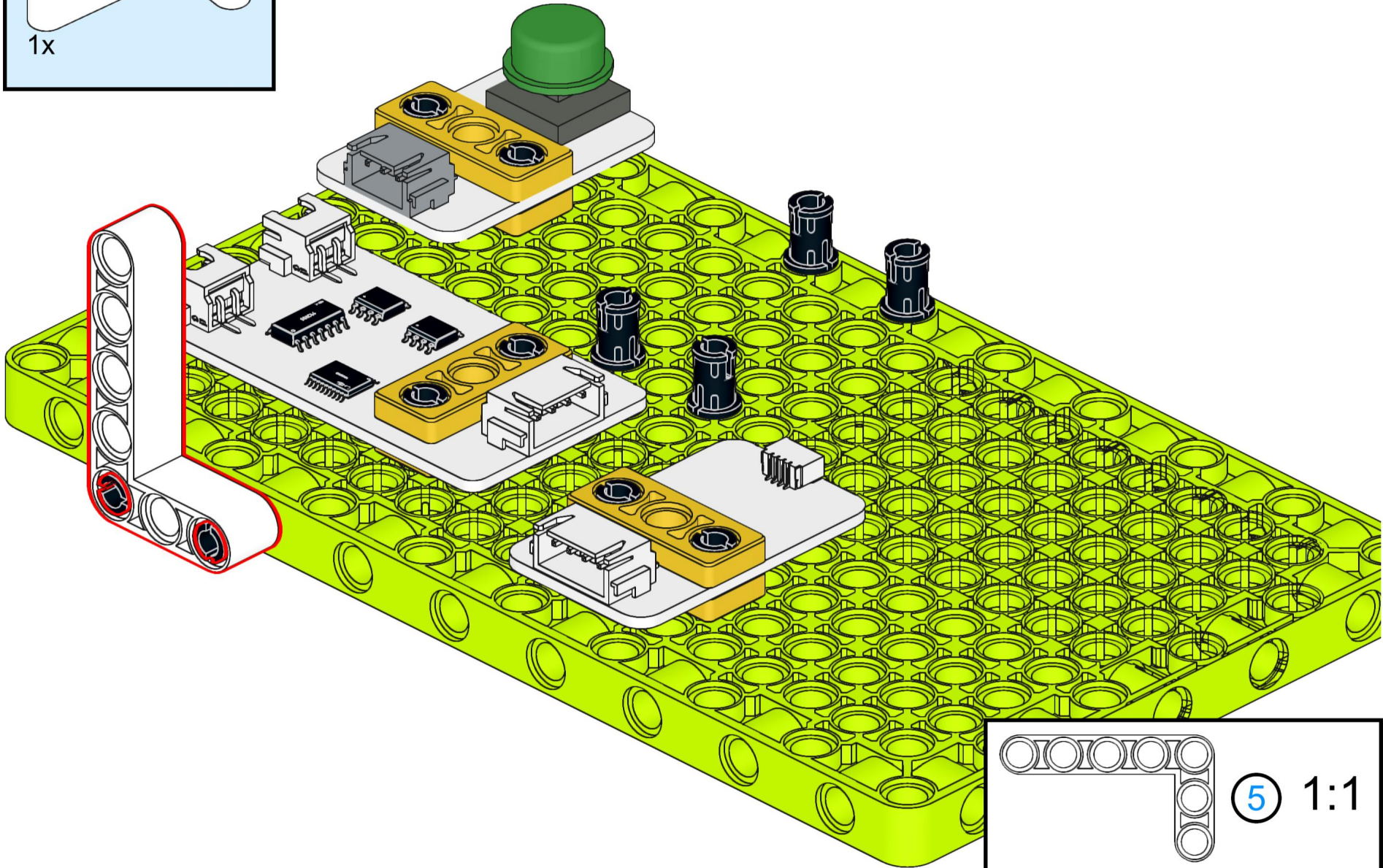
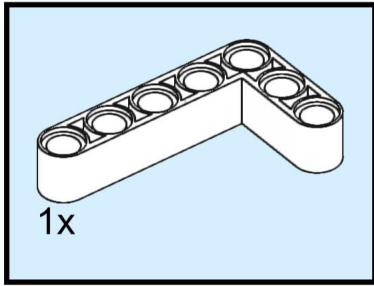

6

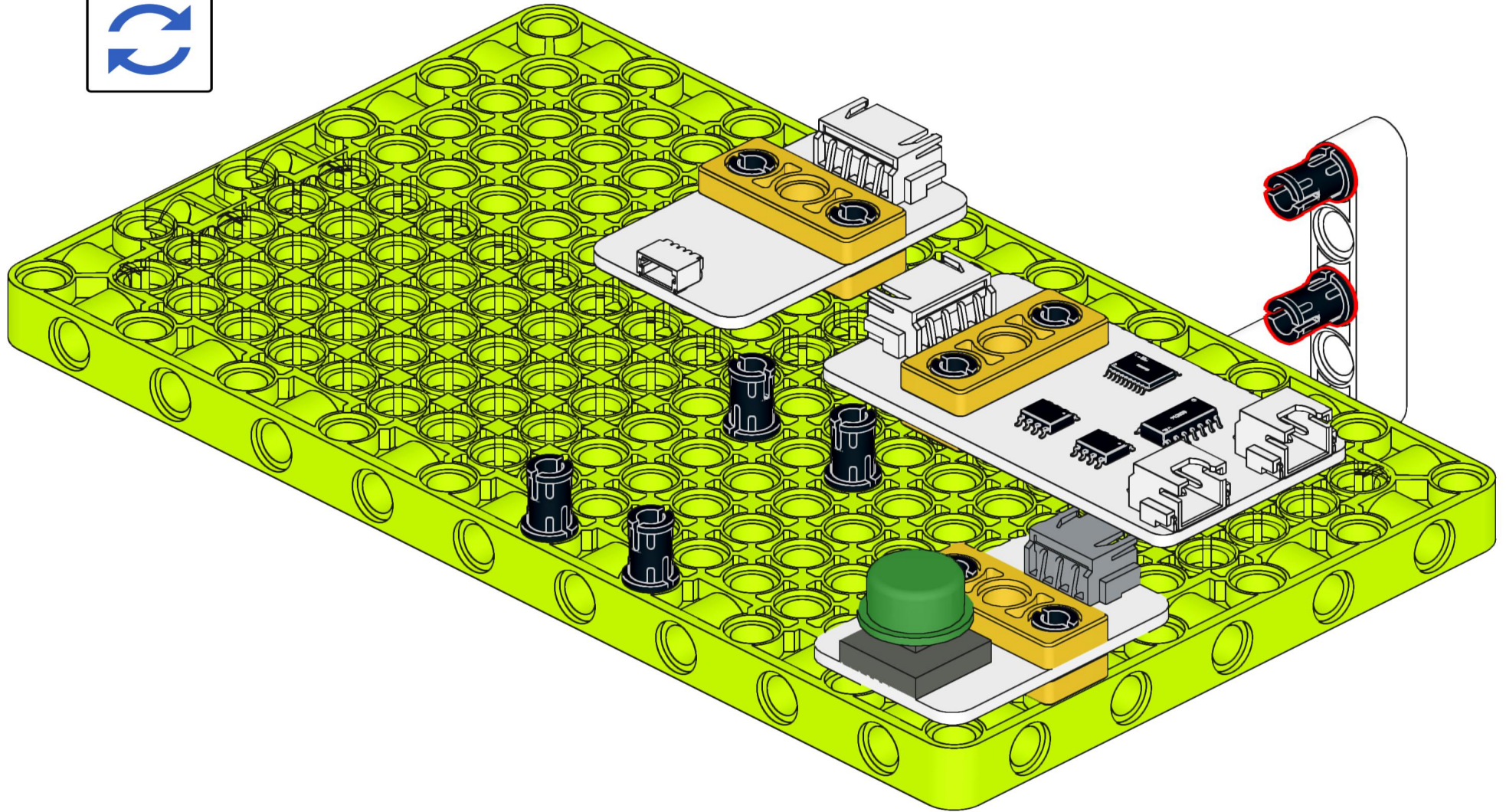
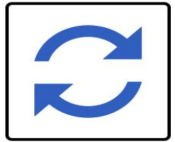

7

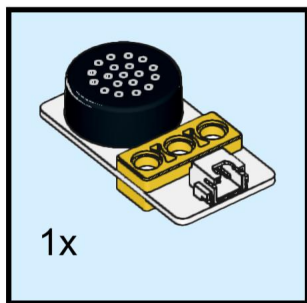

喇叭

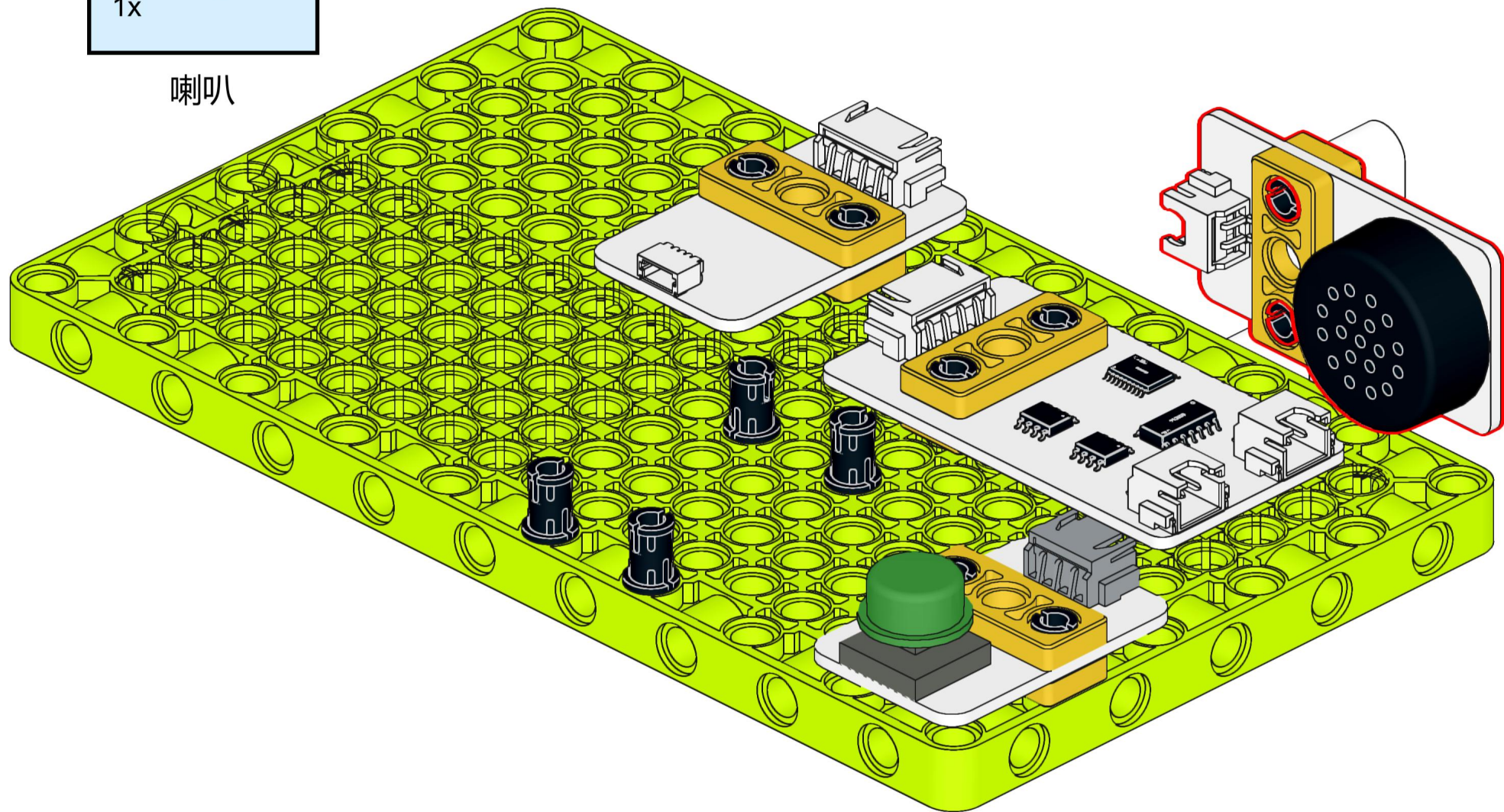

8

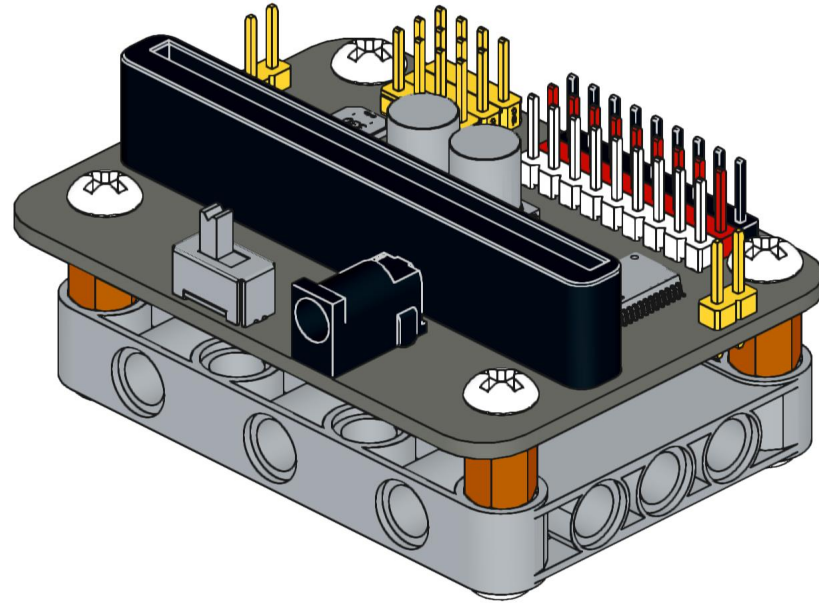

9

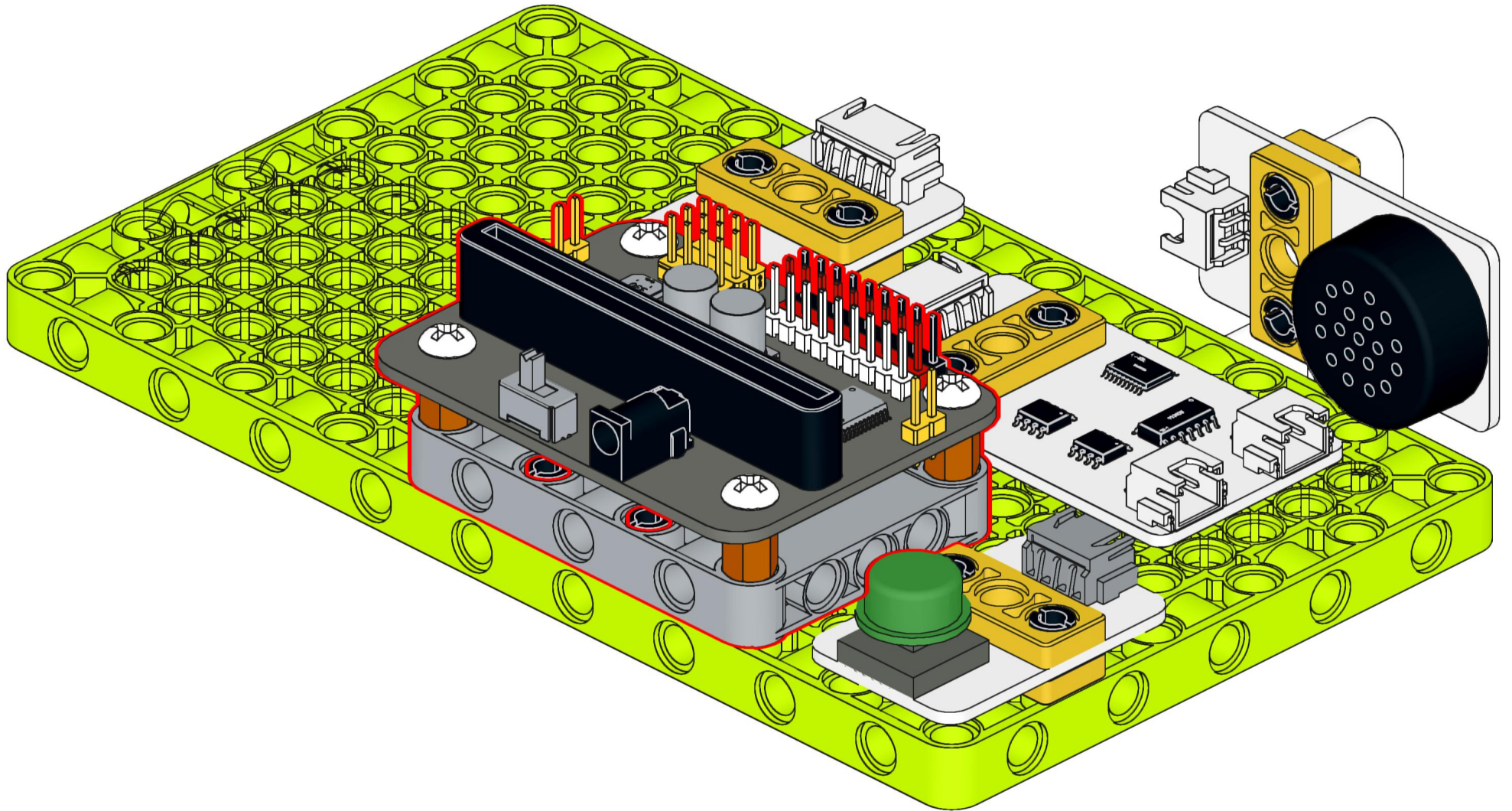

10

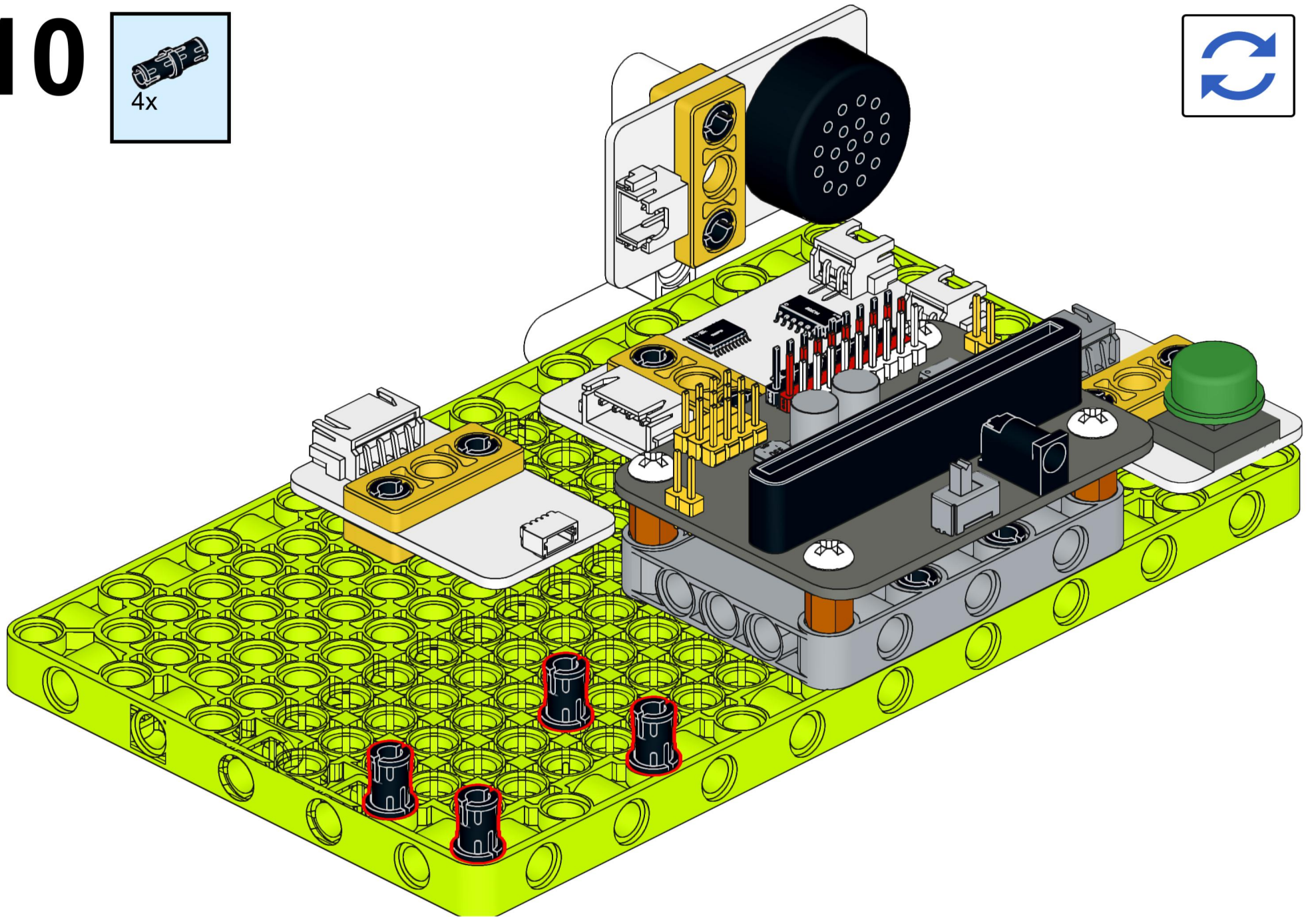
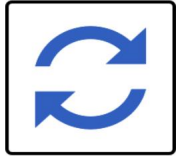

11

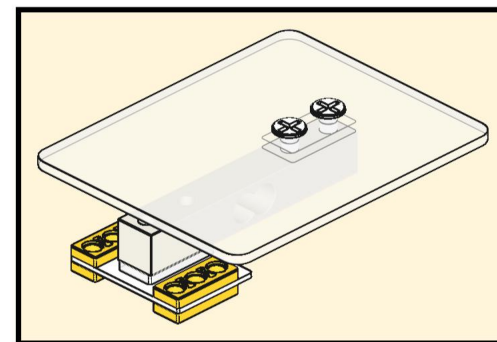
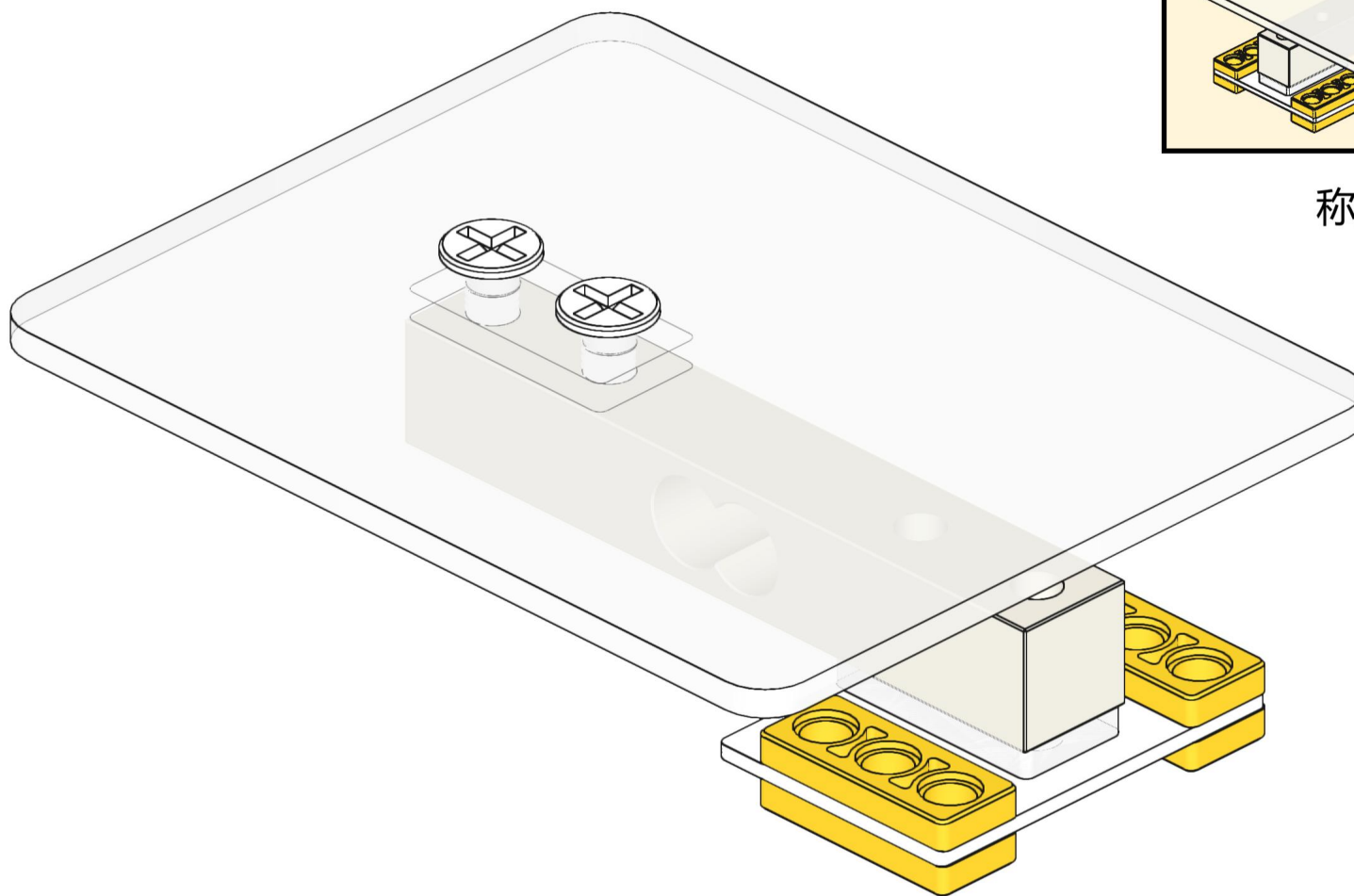

称重模块

12

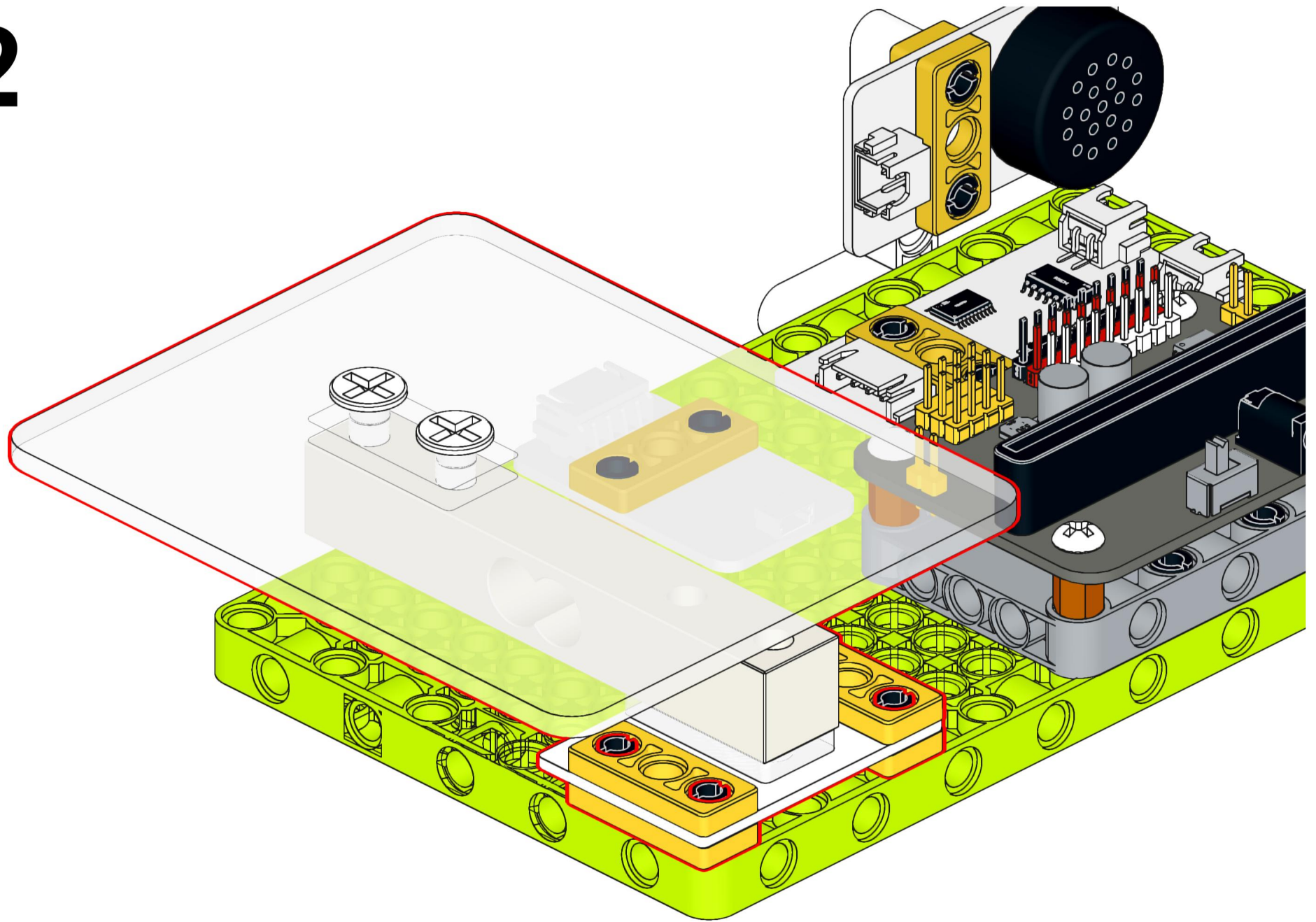

13

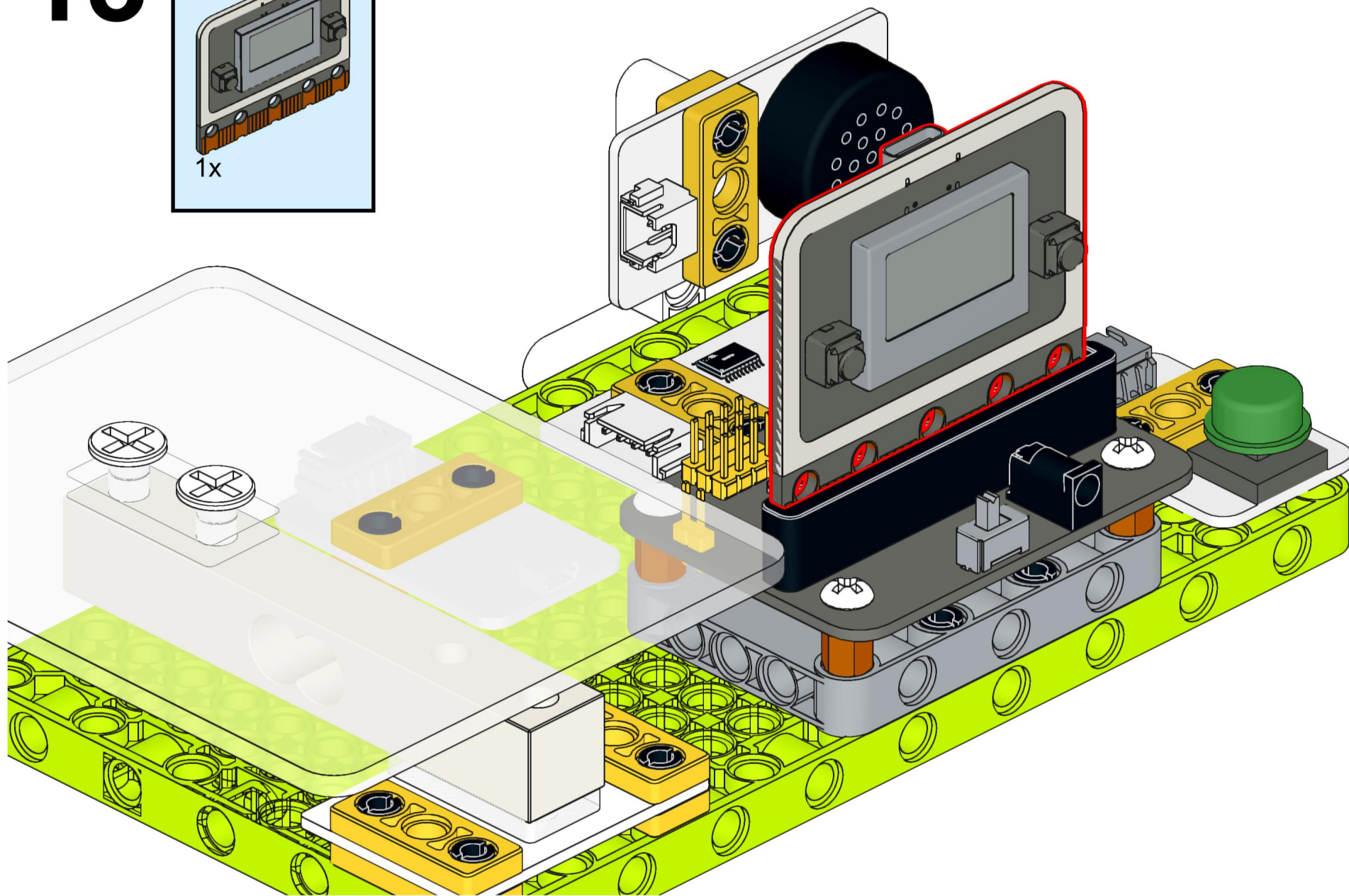
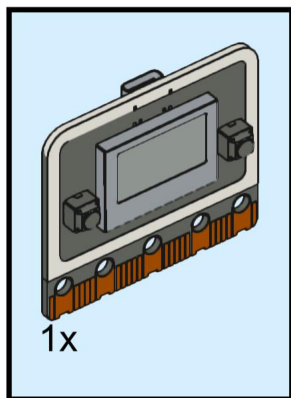

智控电子秤接线图



4-3+1P适配线
(称重转接模块-主控扩展板连接线)

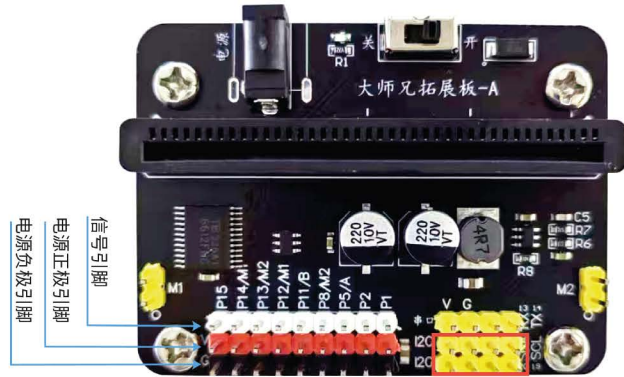

4P (IIC) 适配线



2P适配线-20cm (双路语音合成 - 喇叭连接线)

称重模块的线头



按钮模块

双路语音合成模块
称重转接模块SCK (P1)
称重转接模块DT (P2)

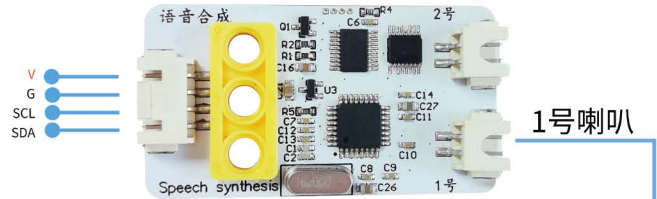

1号喇叭

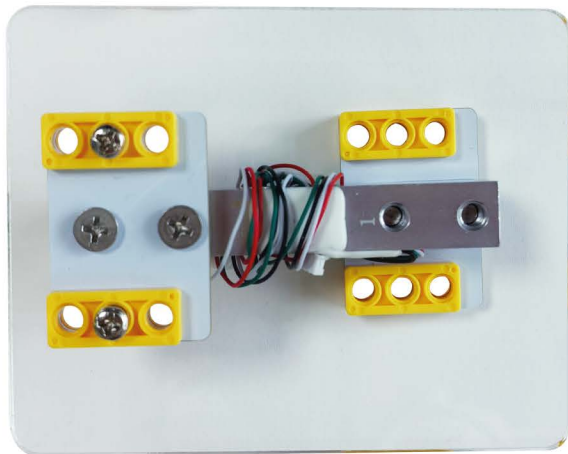

接线说明:

- 1、连接线的白色头与对应的传感器相连;
- 2、连接线的黑色头 (杜邦线头) 与扩展版相连;
- 3、3P适配线与扩展版相连时颜色要对应;
- 4、双路语音合成模块使用4P (I2C) 线连接至扩展版任意I2C接口。其中, 红线对应V引脚, 黑线对应G引脚;
- 5、喇叭用2P适配线 (短线) 与双路语音合成模块1号口相连;
- 6、称重转接模块一端连接称重模块, 另一端用4-3+1P适配线同扩展板连接, 合在一起的3pin线接P1接口, 单独的线接P2接口。

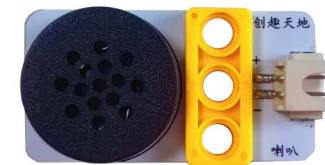

1号喇叭



3P适配线