

# 分区智能广播

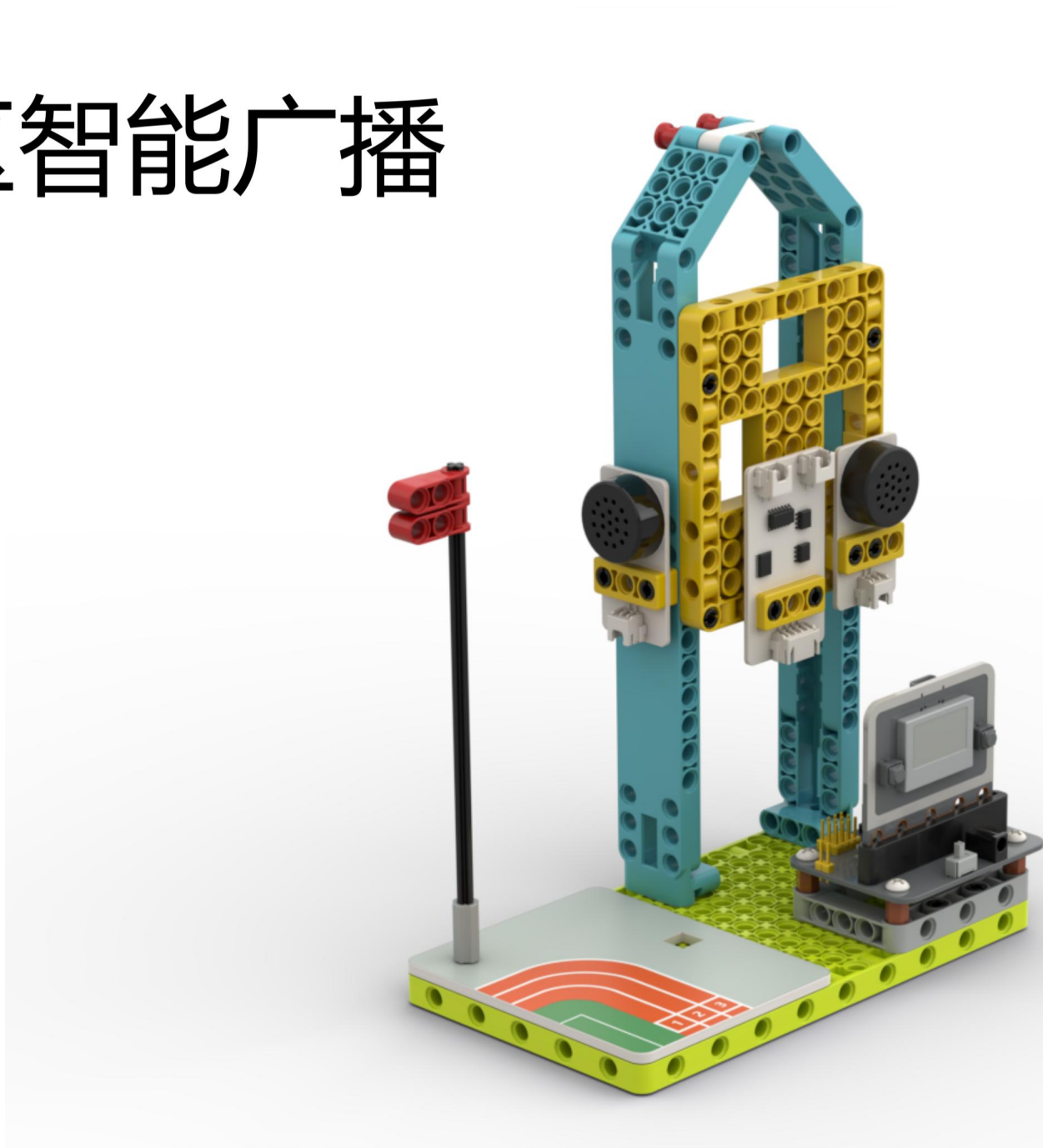

1

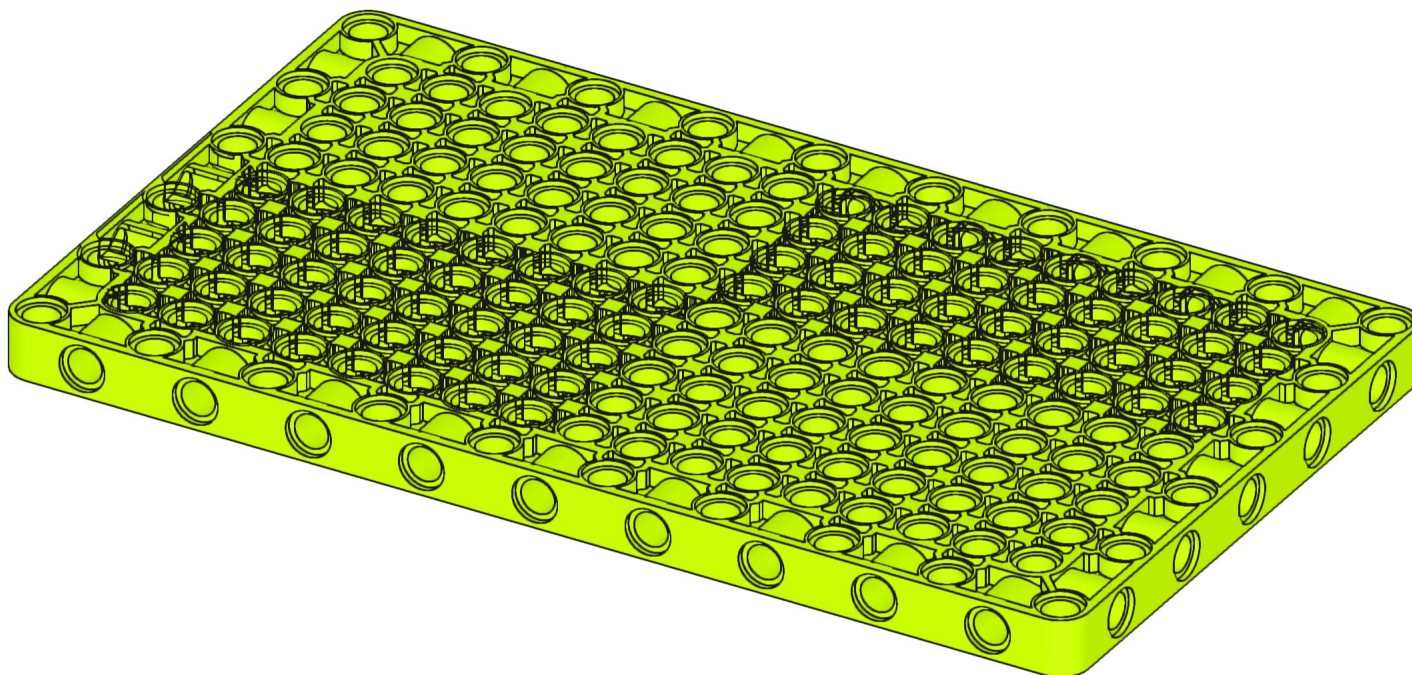
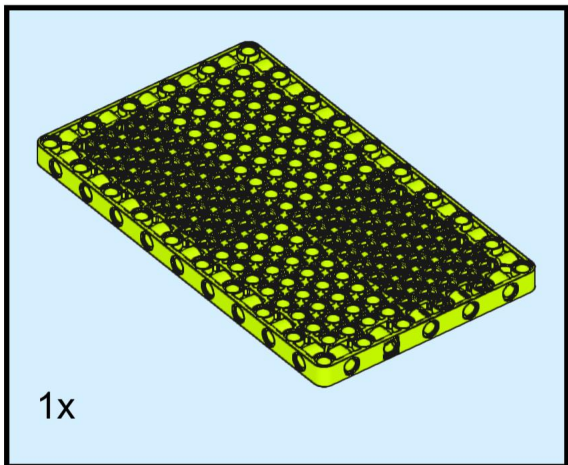

2

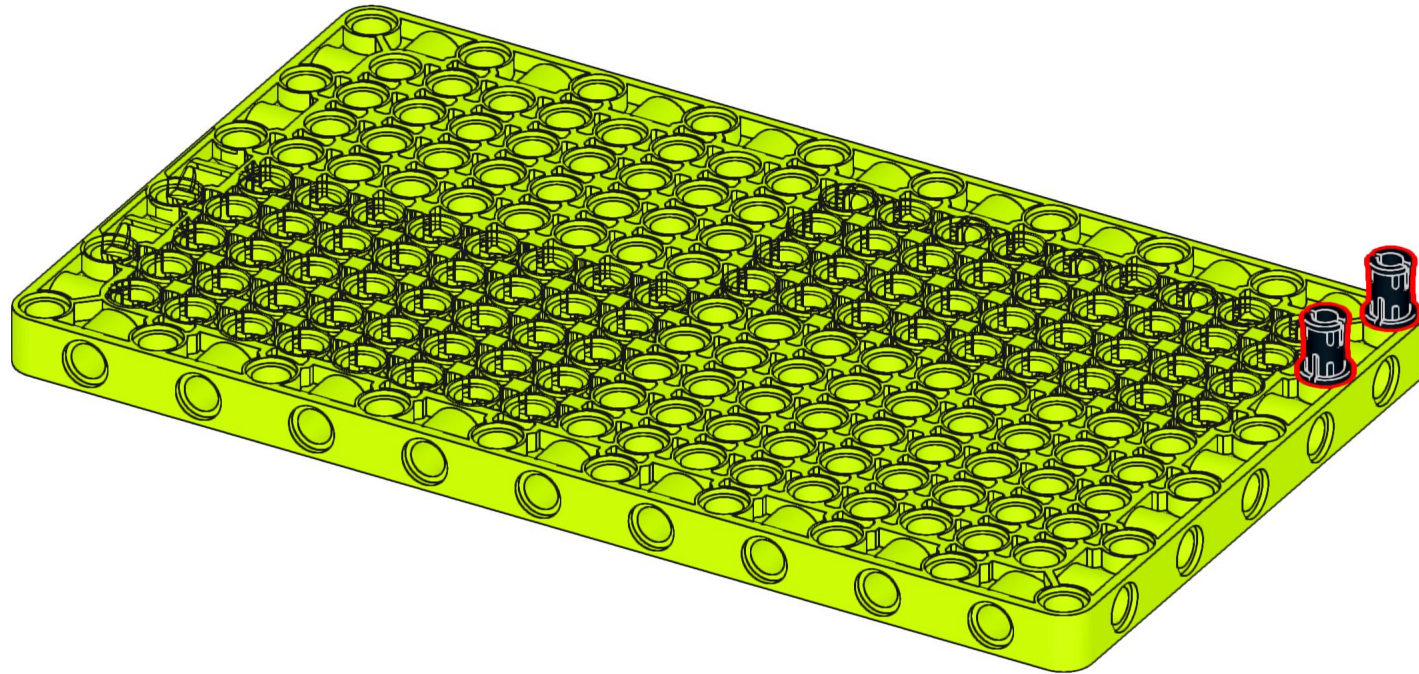

3

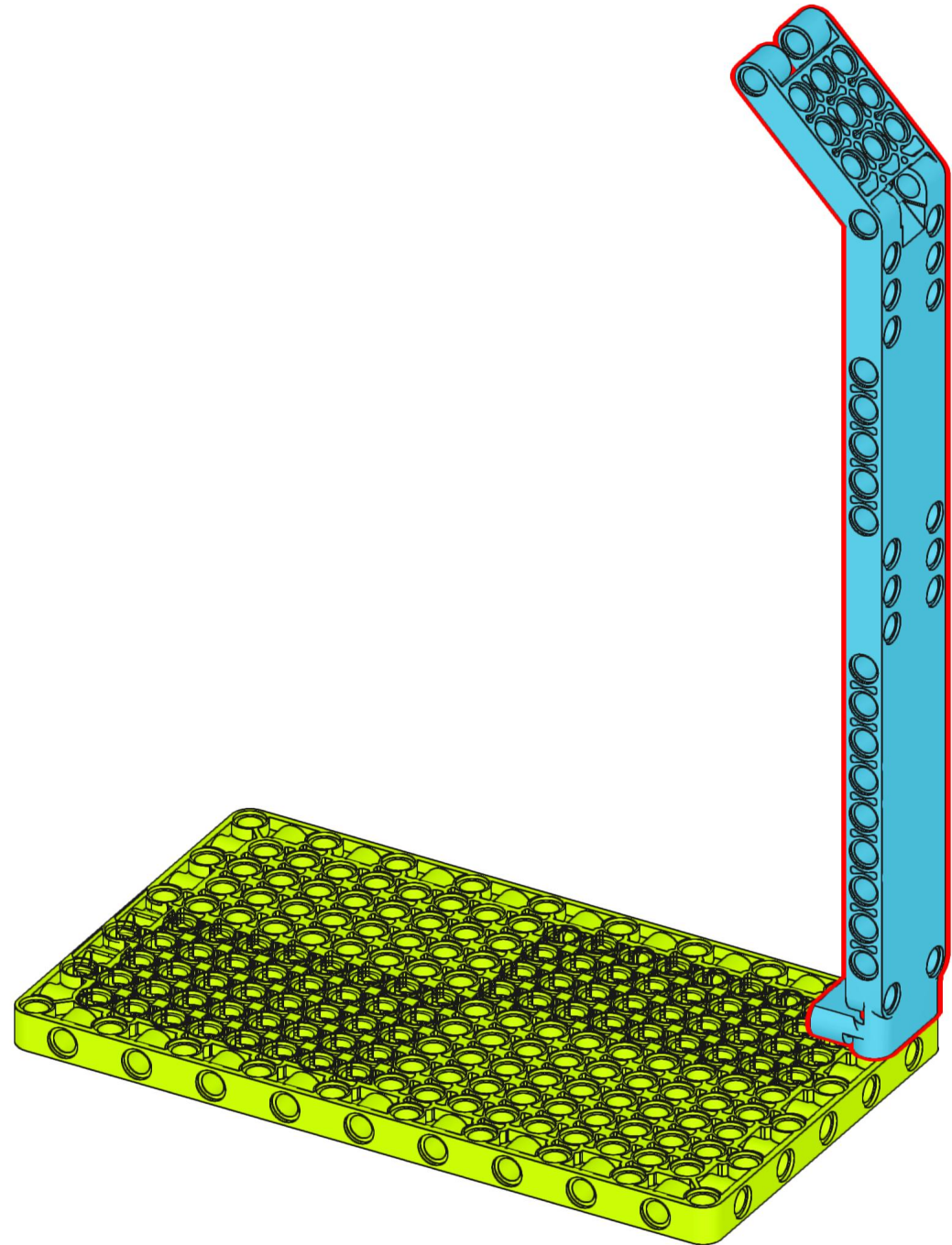
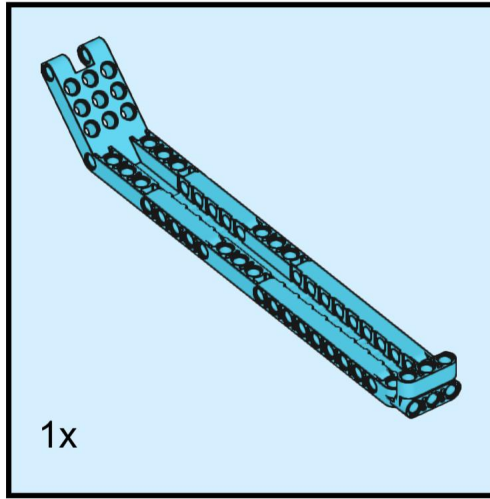

4

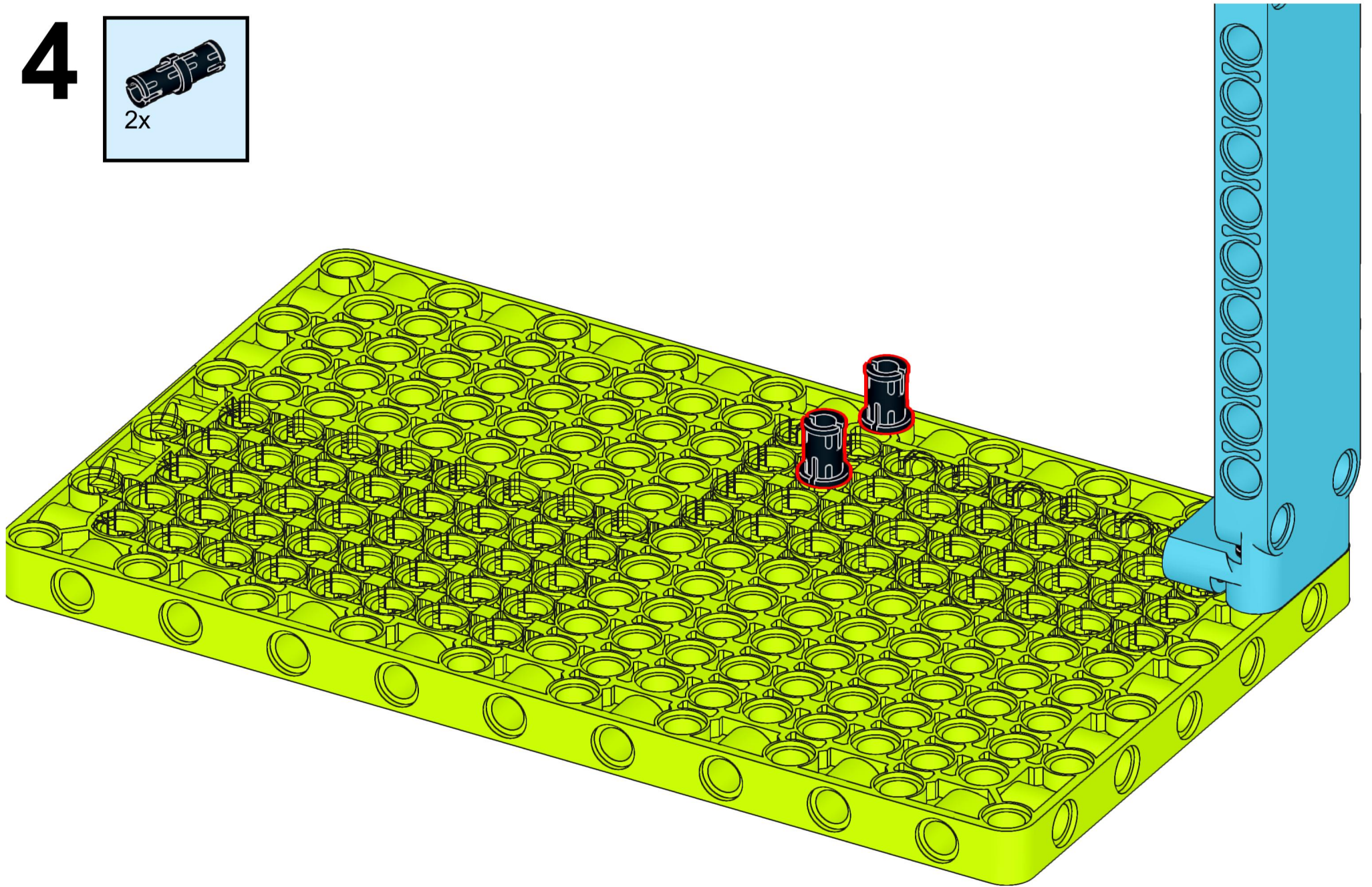

5

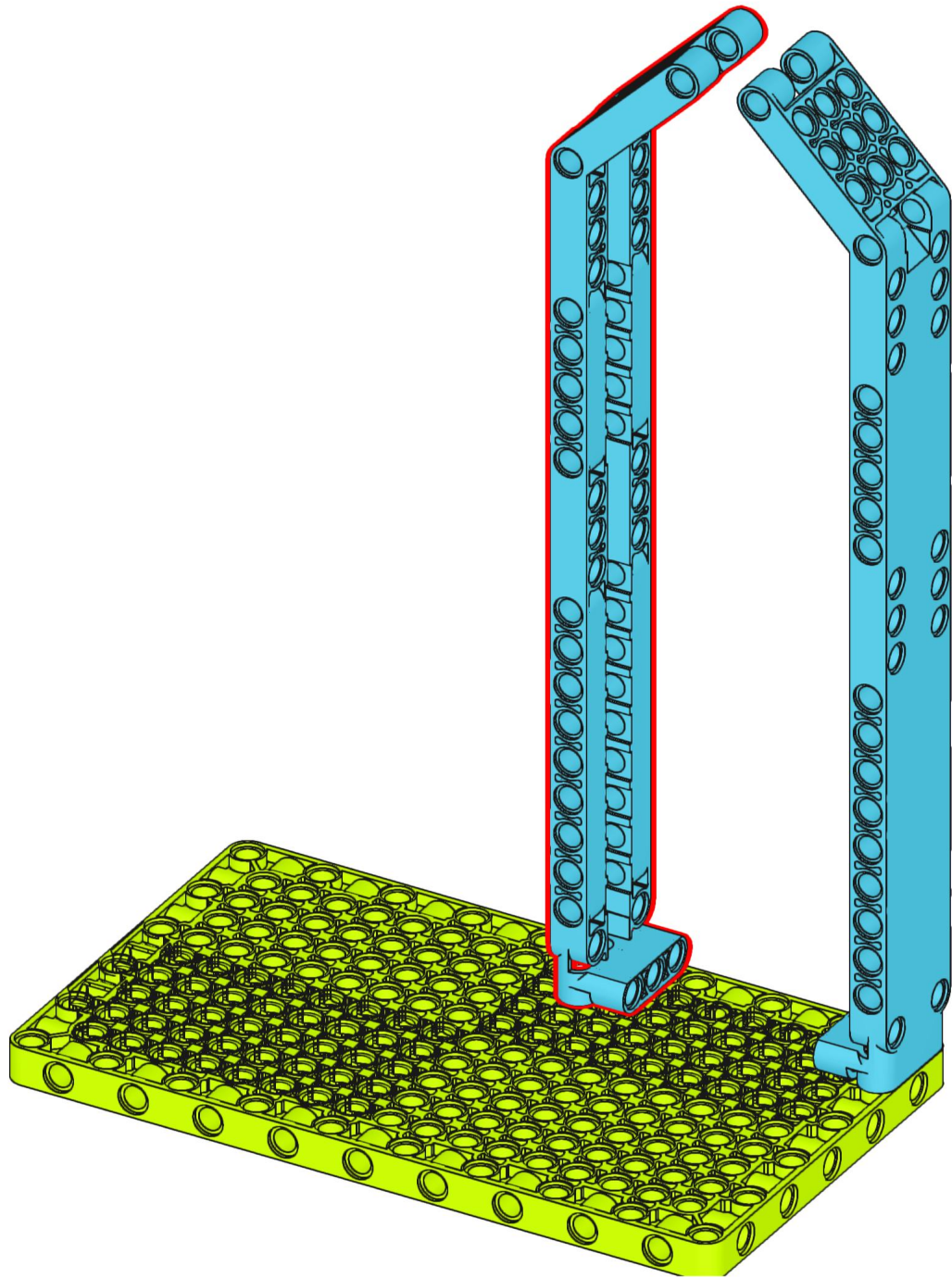
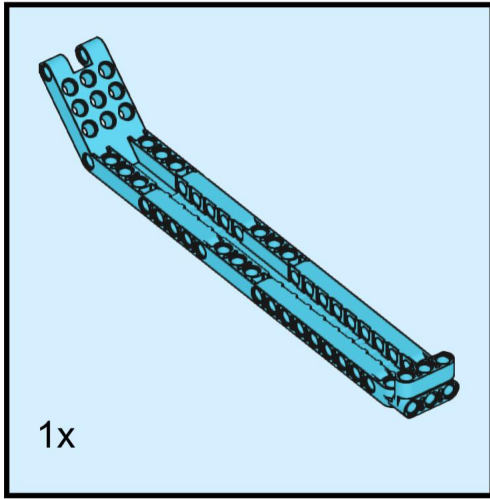

6

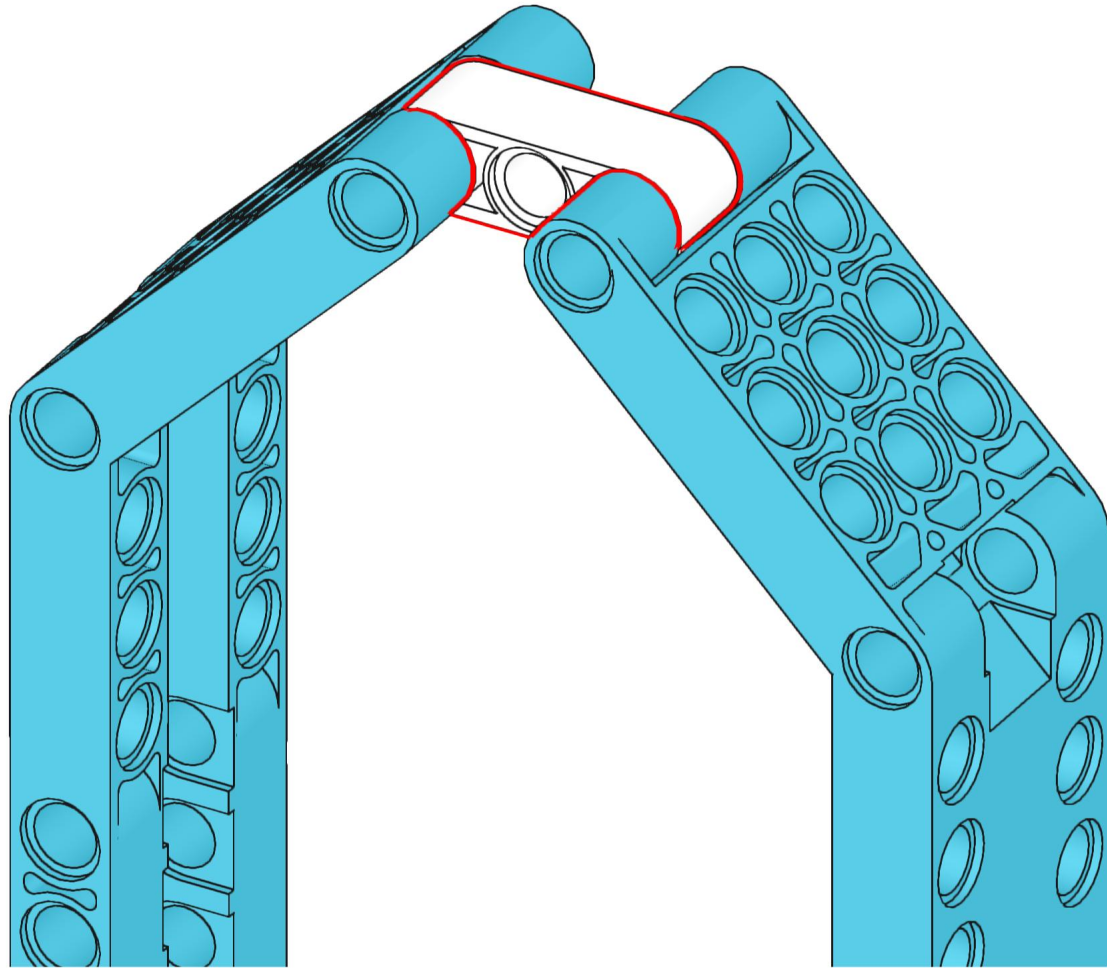
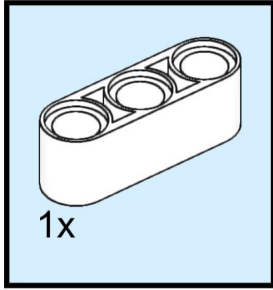

7

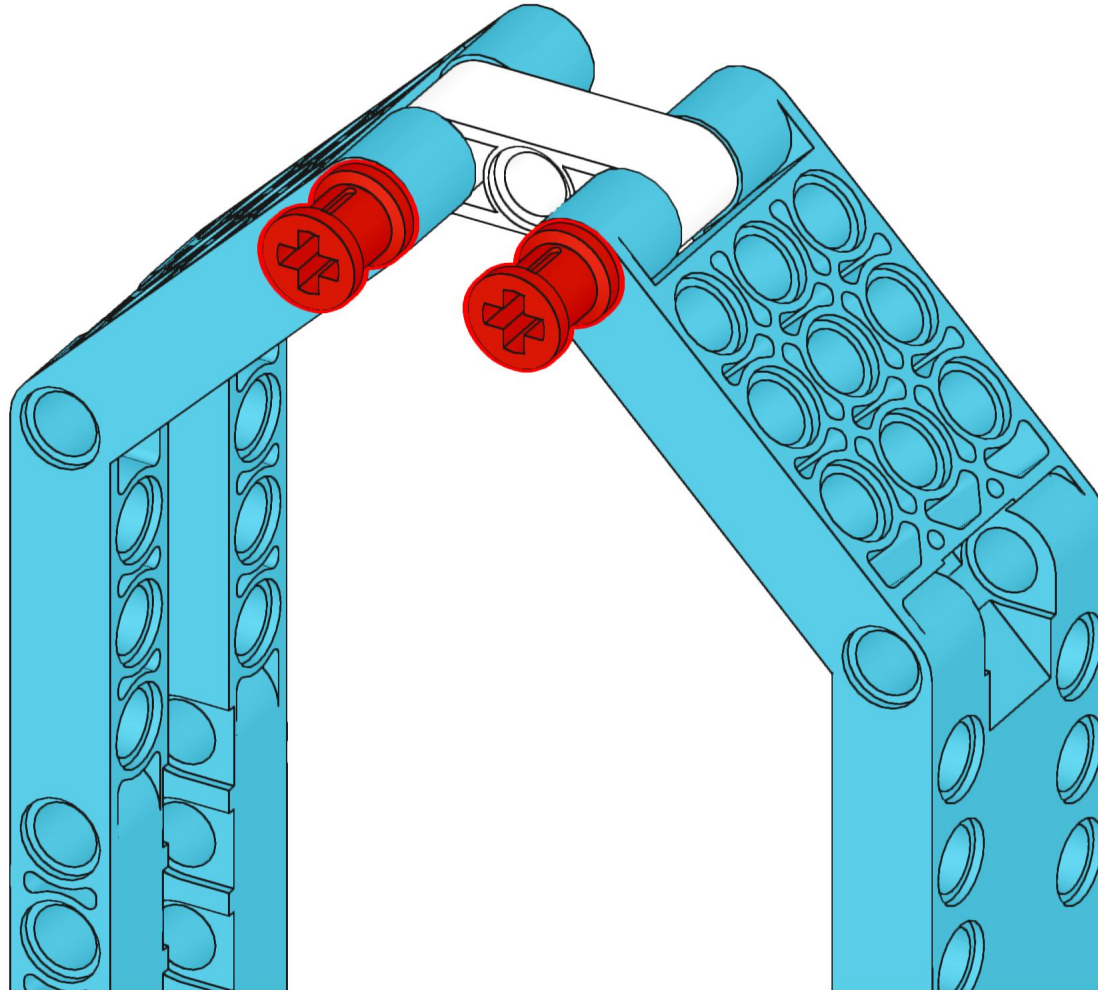
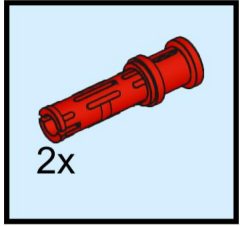

8

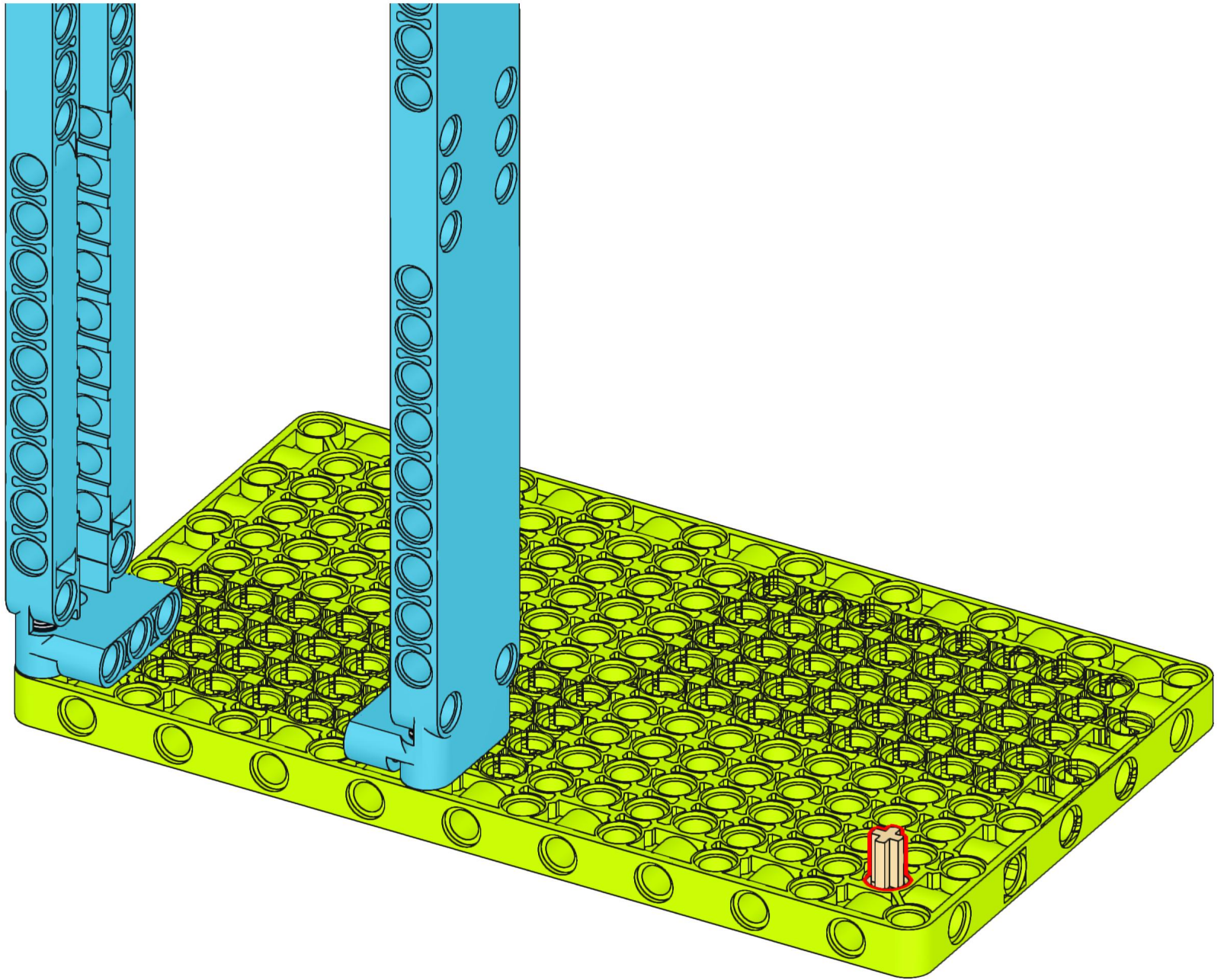
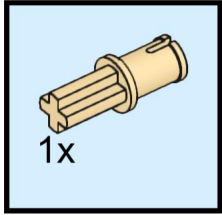

9

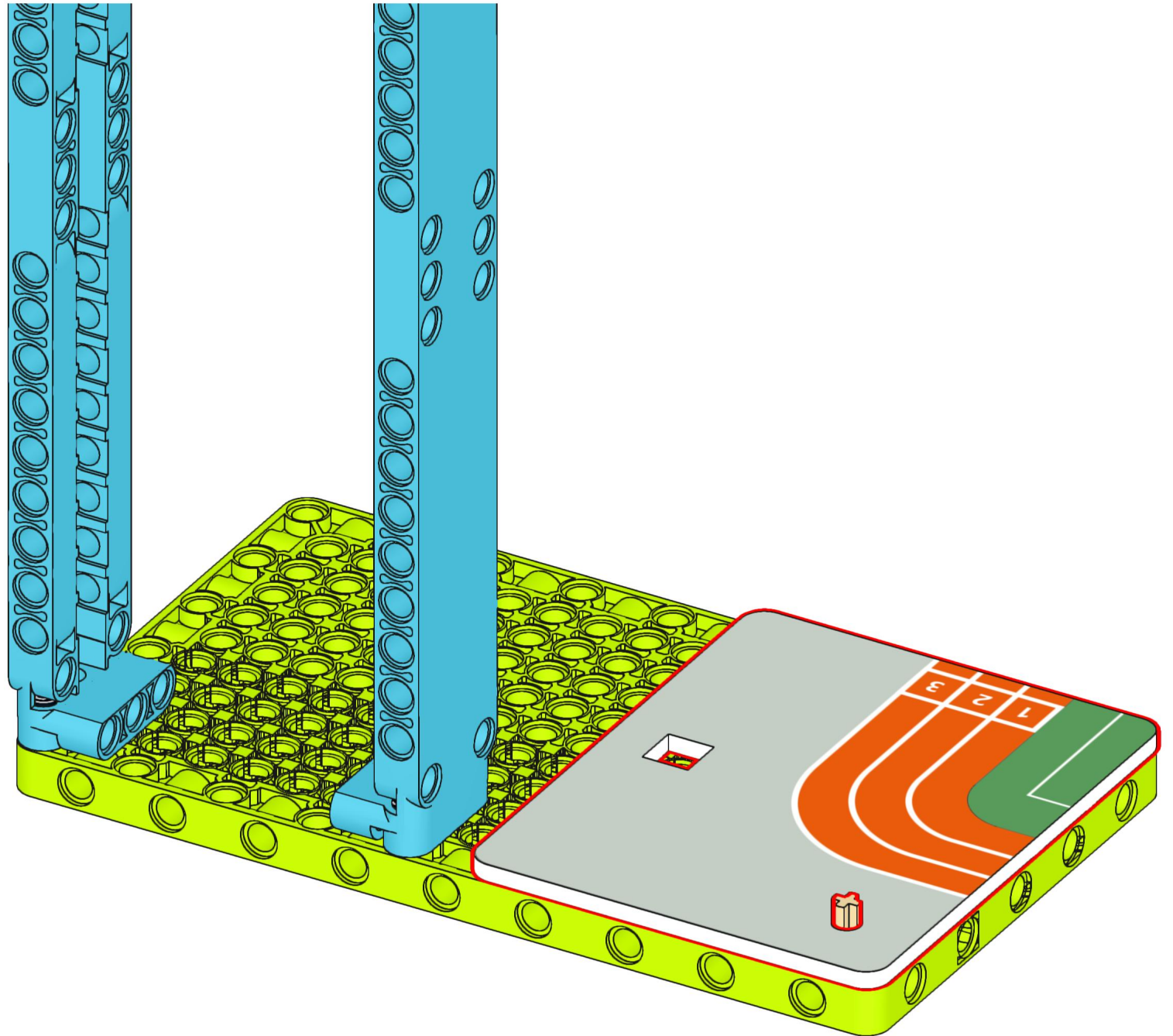
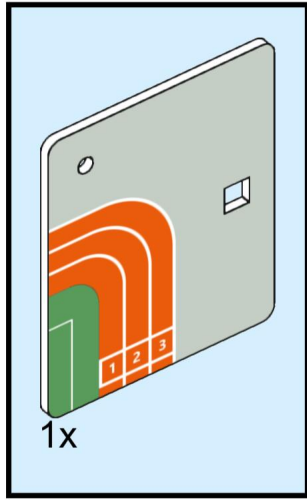

# 10

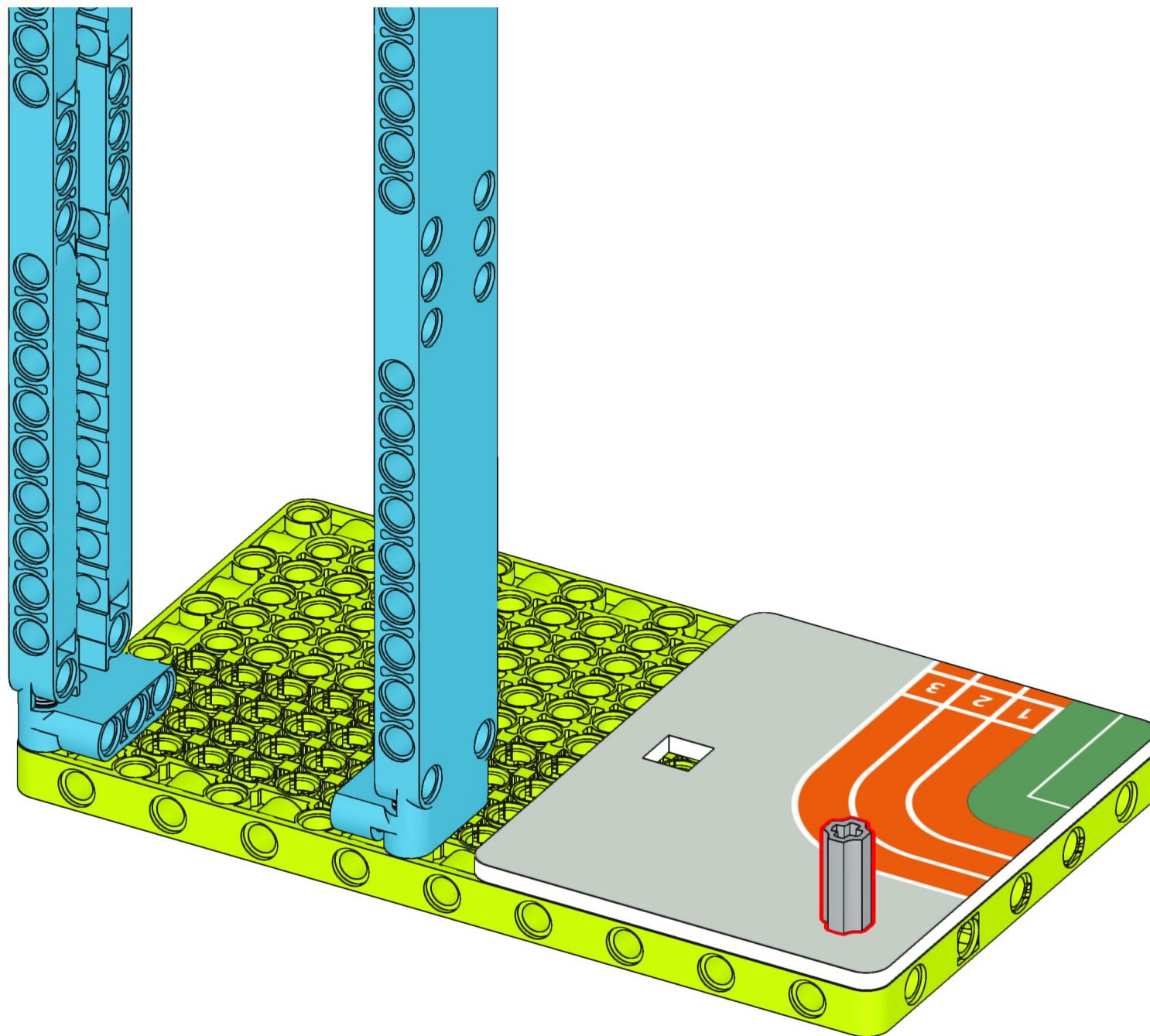
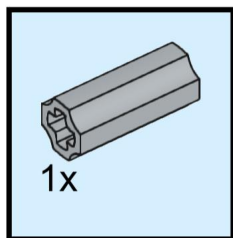

# 11

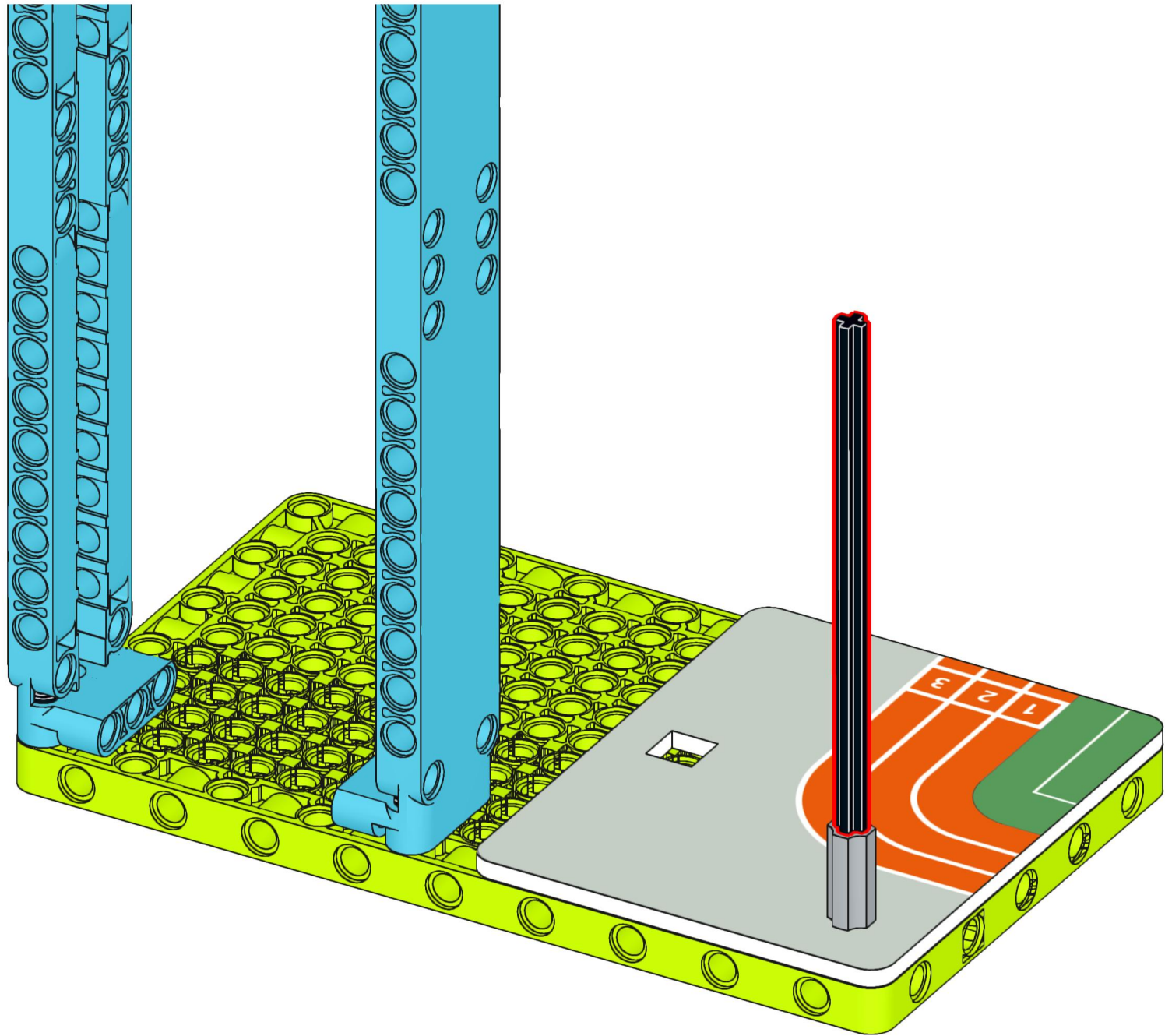
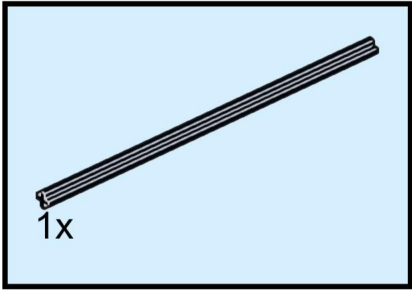

# 12

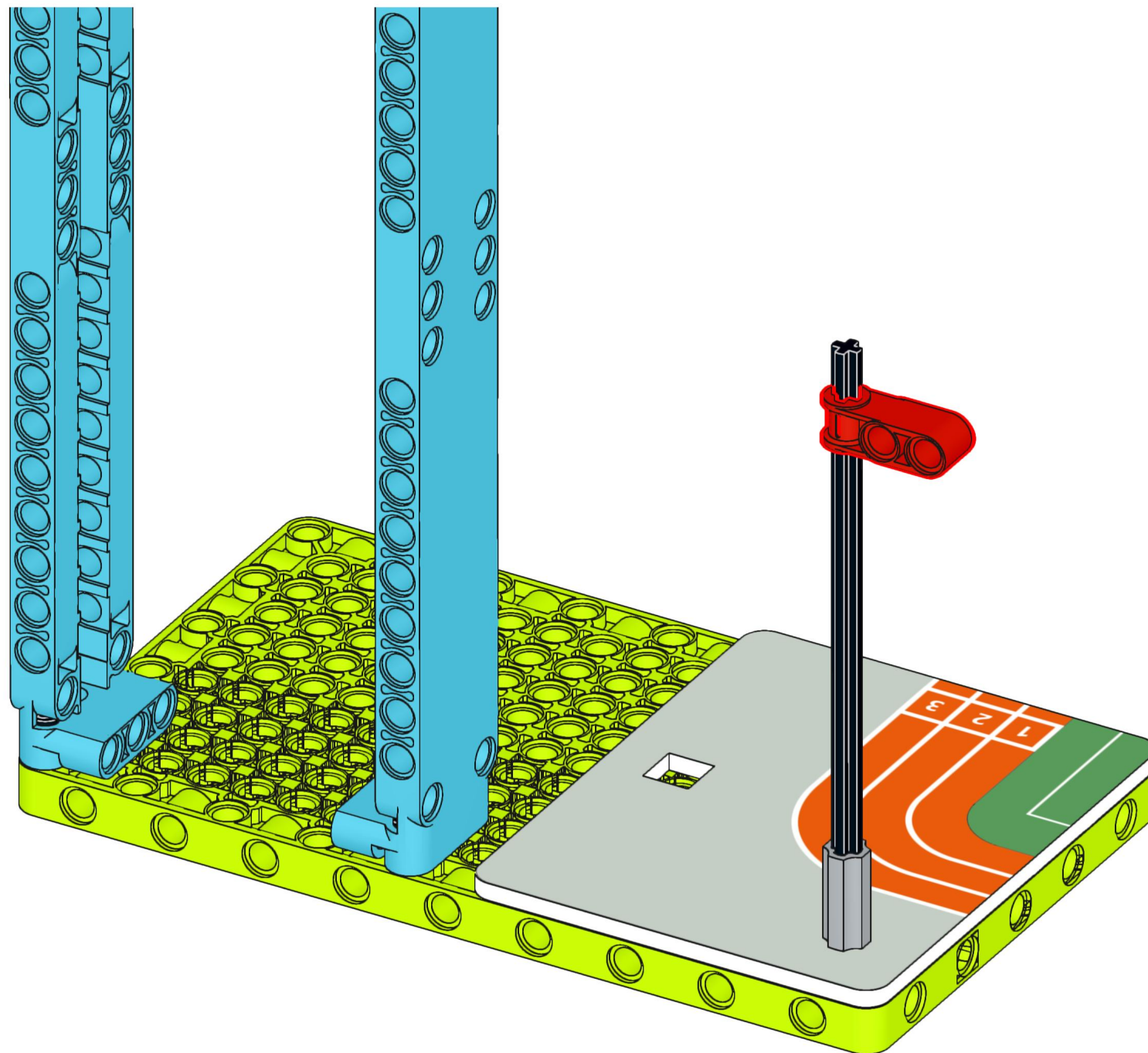
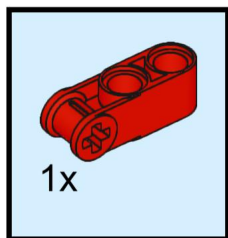

# 13

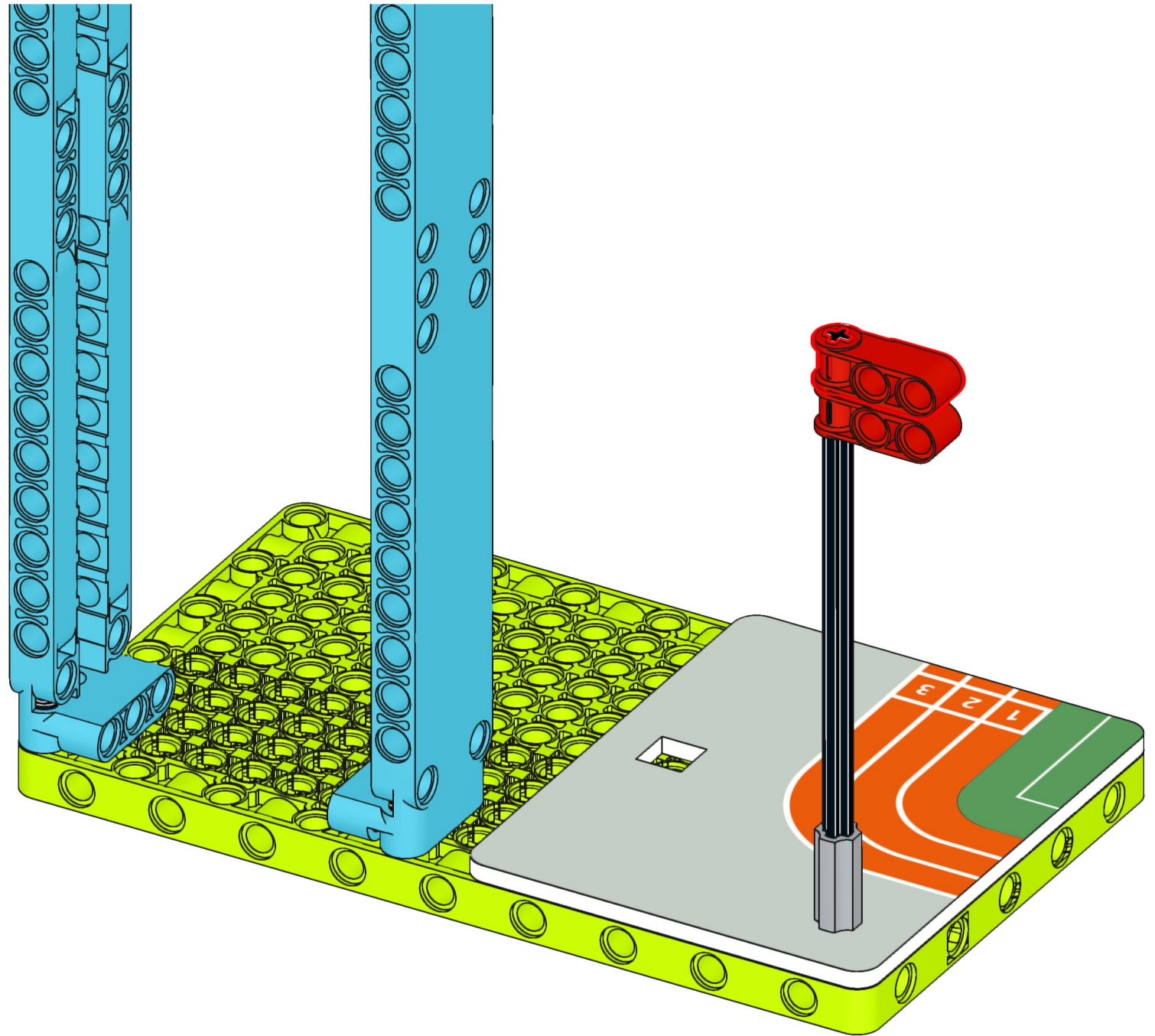
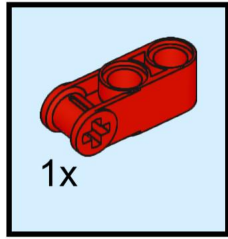

# 14

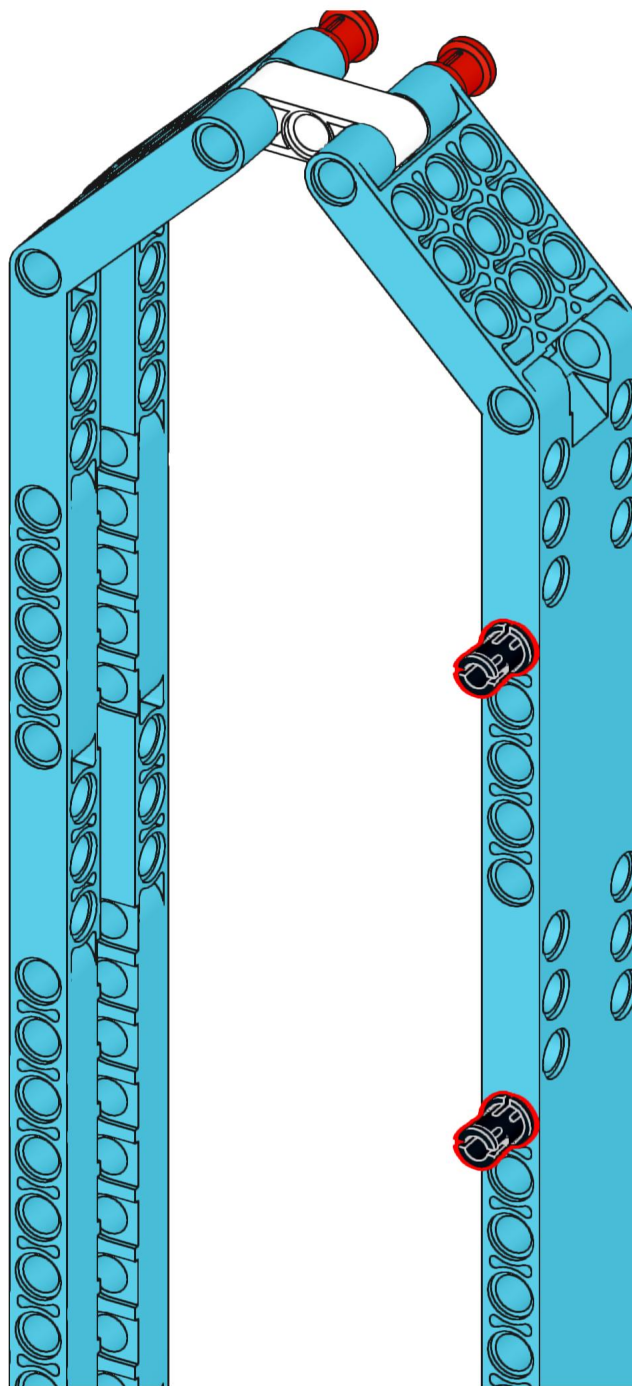
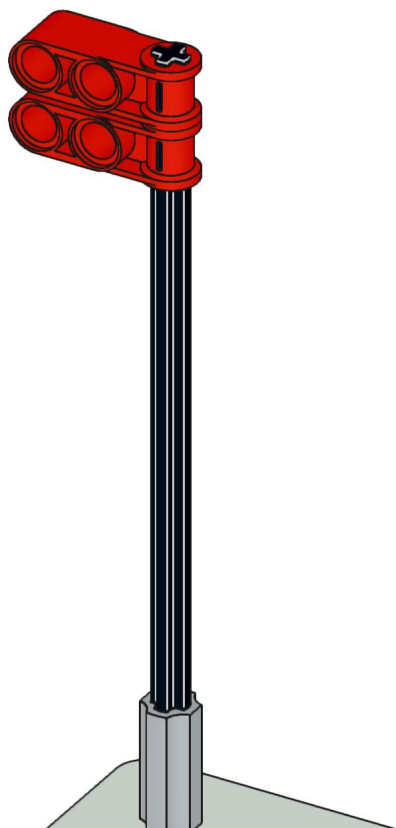
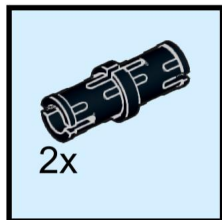

# 15

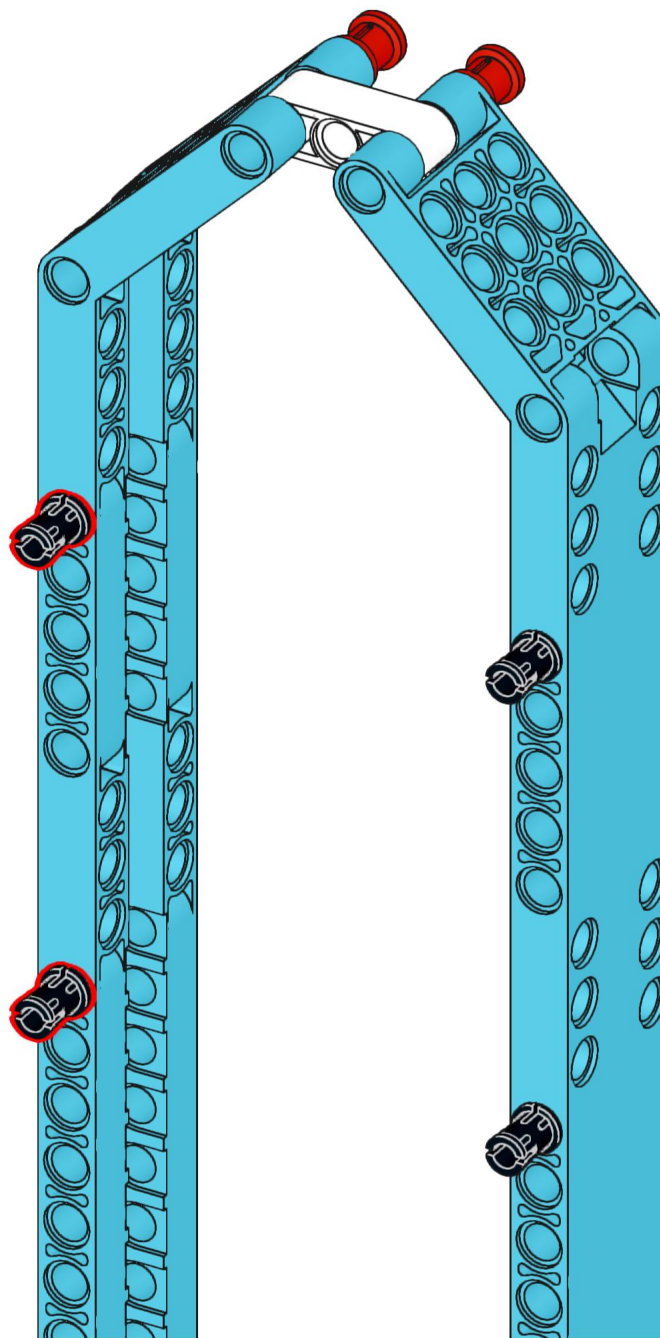
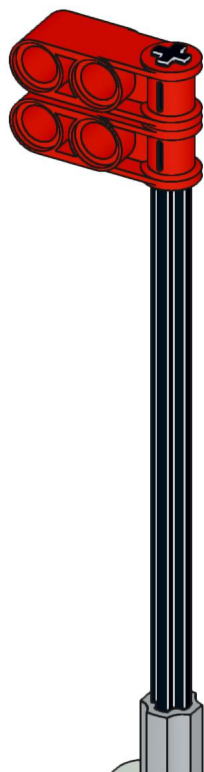
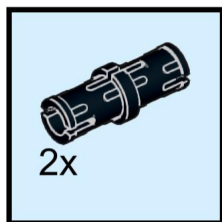

# 16

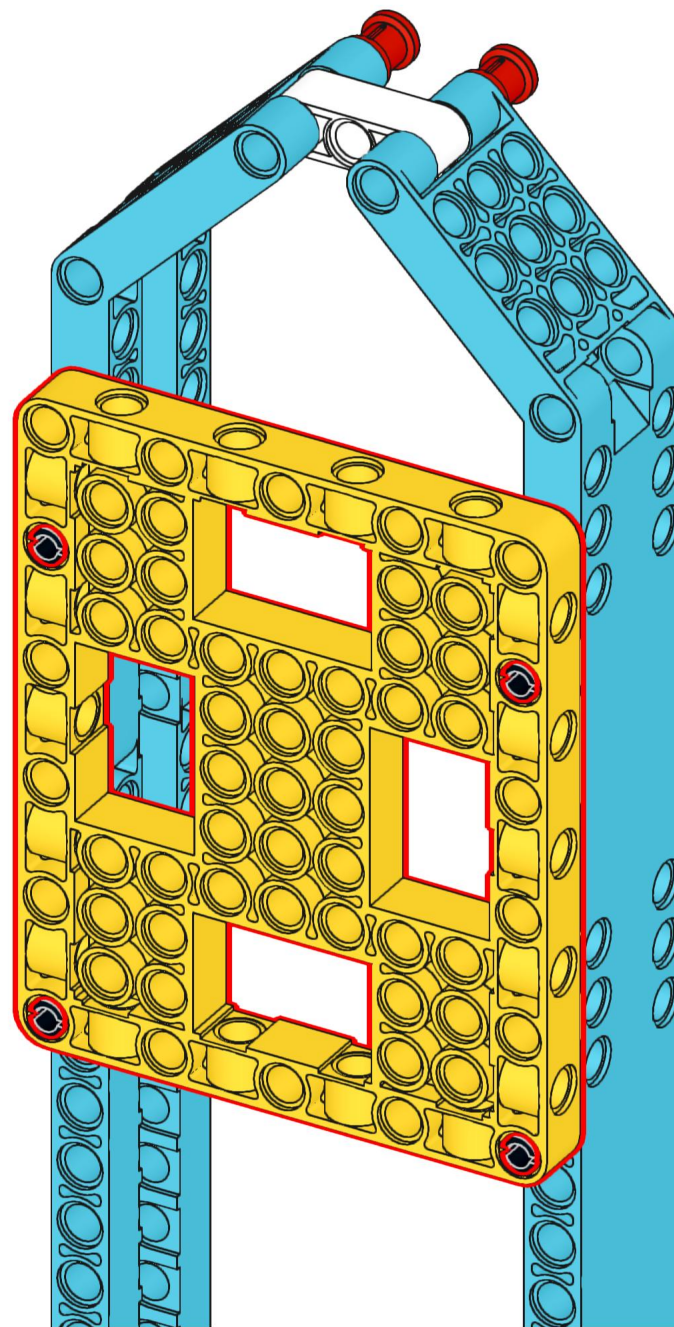
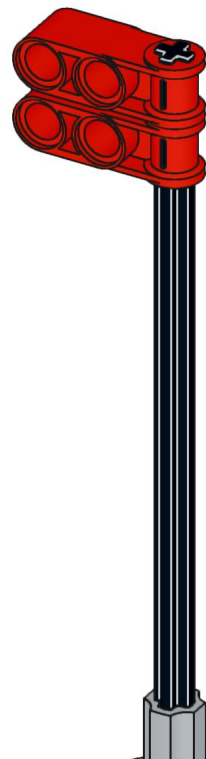
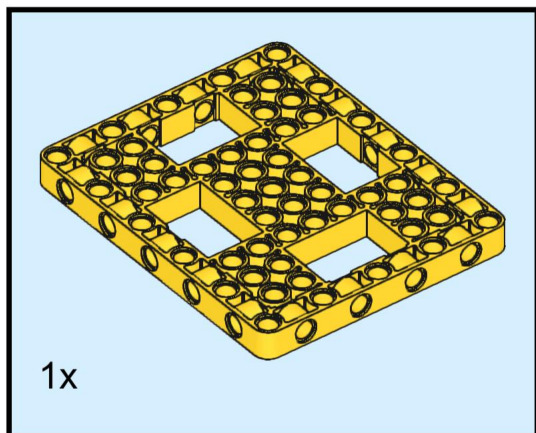

# 17

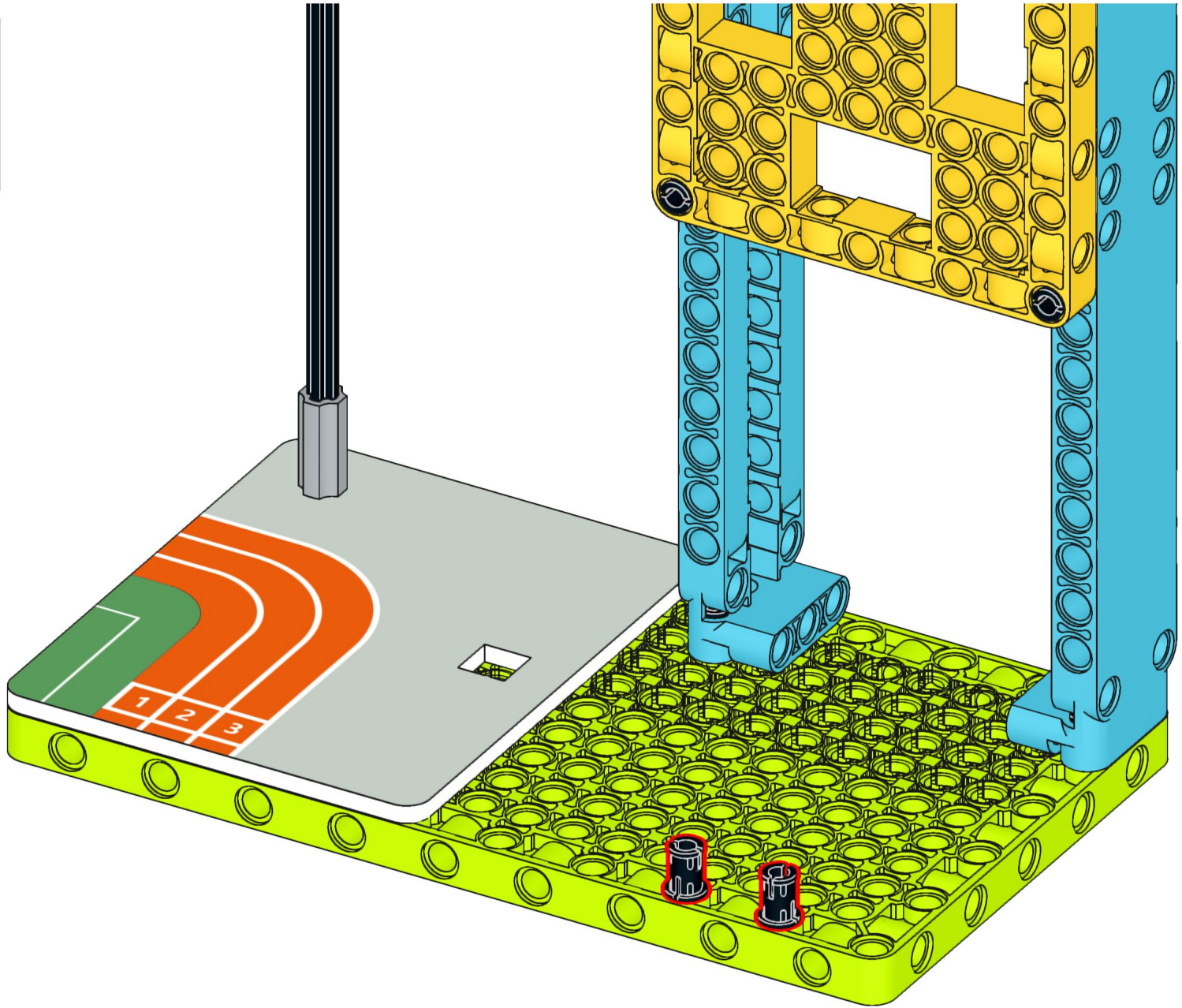

# 18

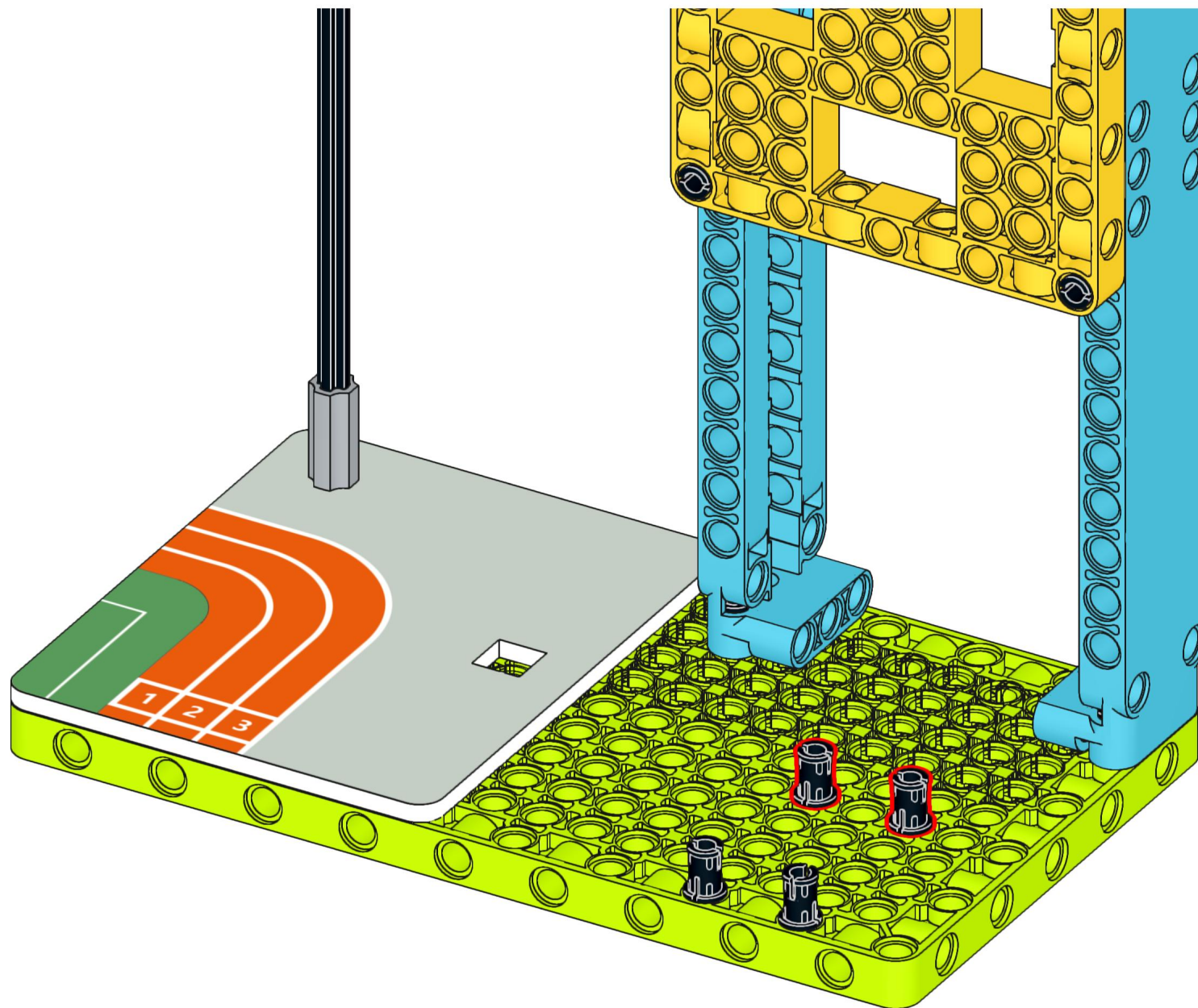
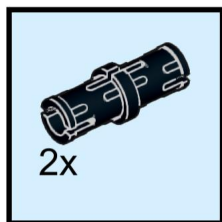

# 19

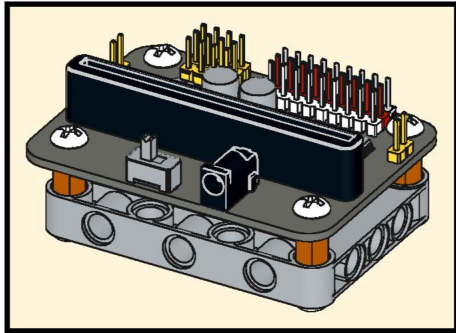

# 20

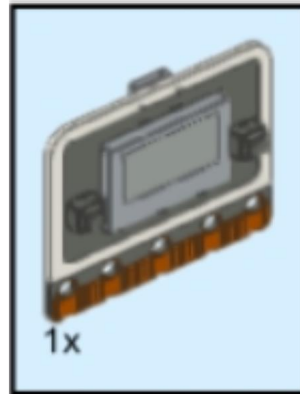

# 21

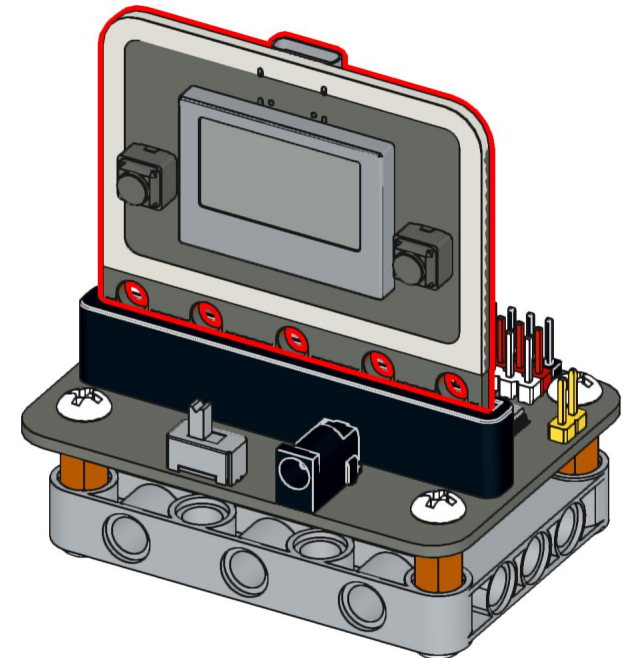
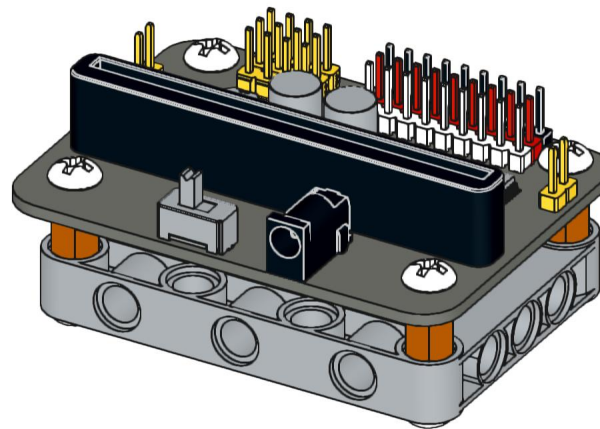
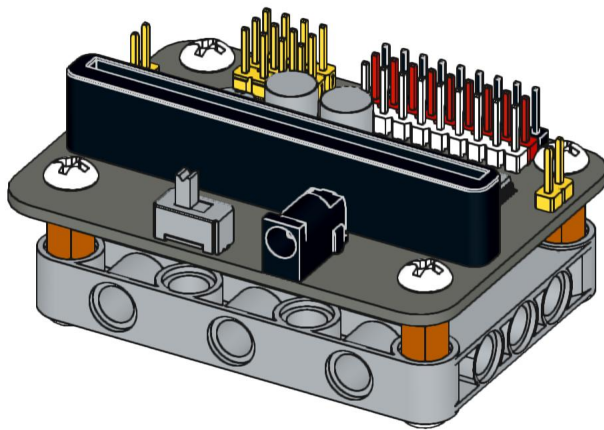
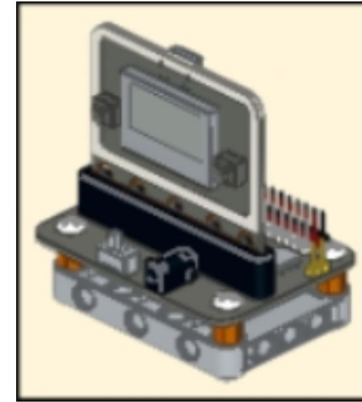

# 22

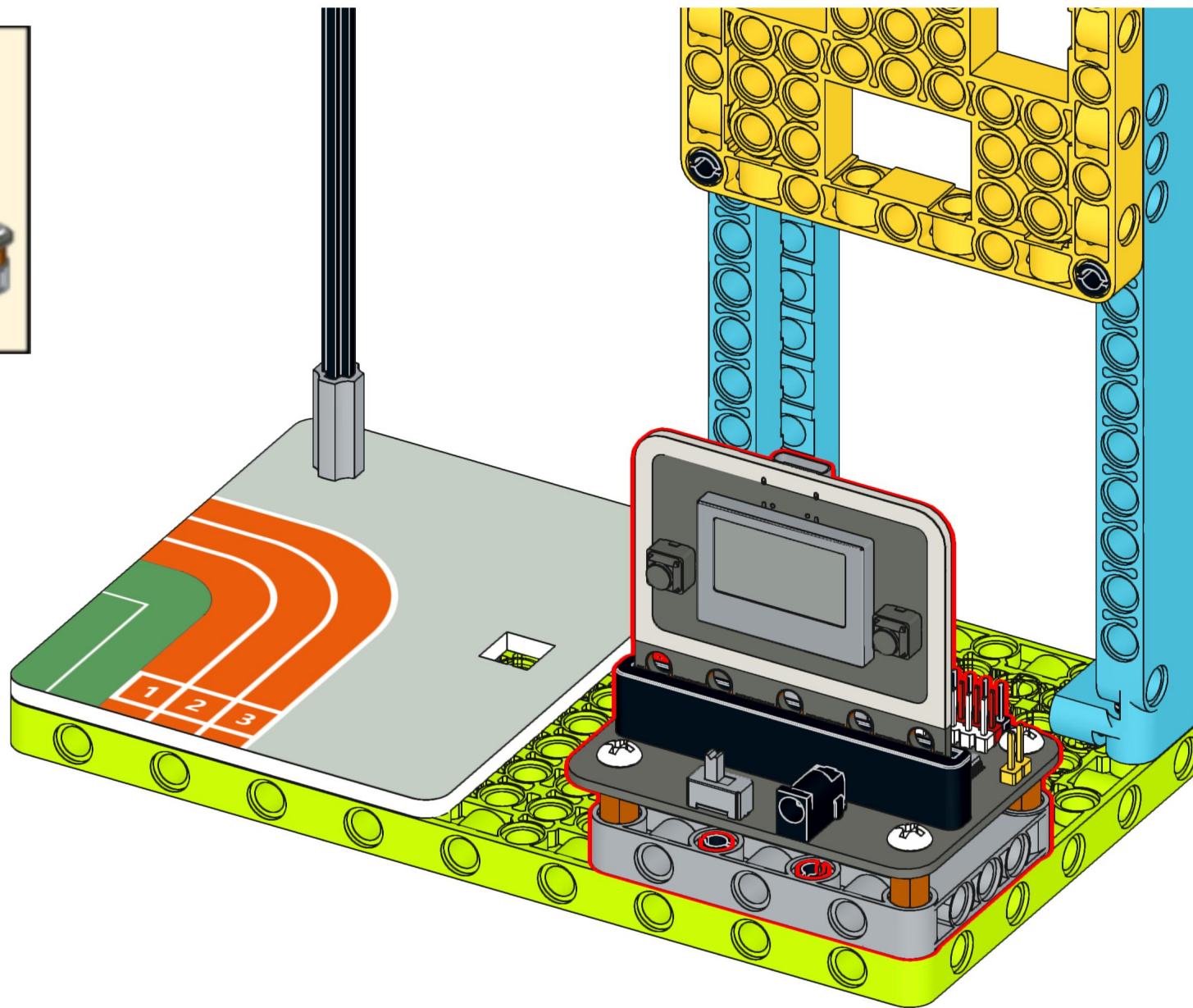
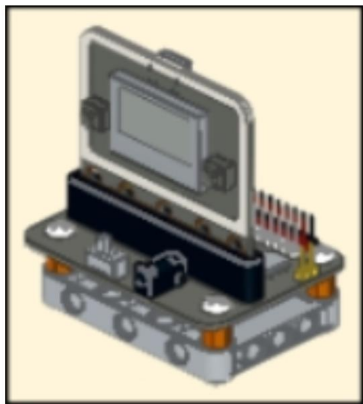

# 23

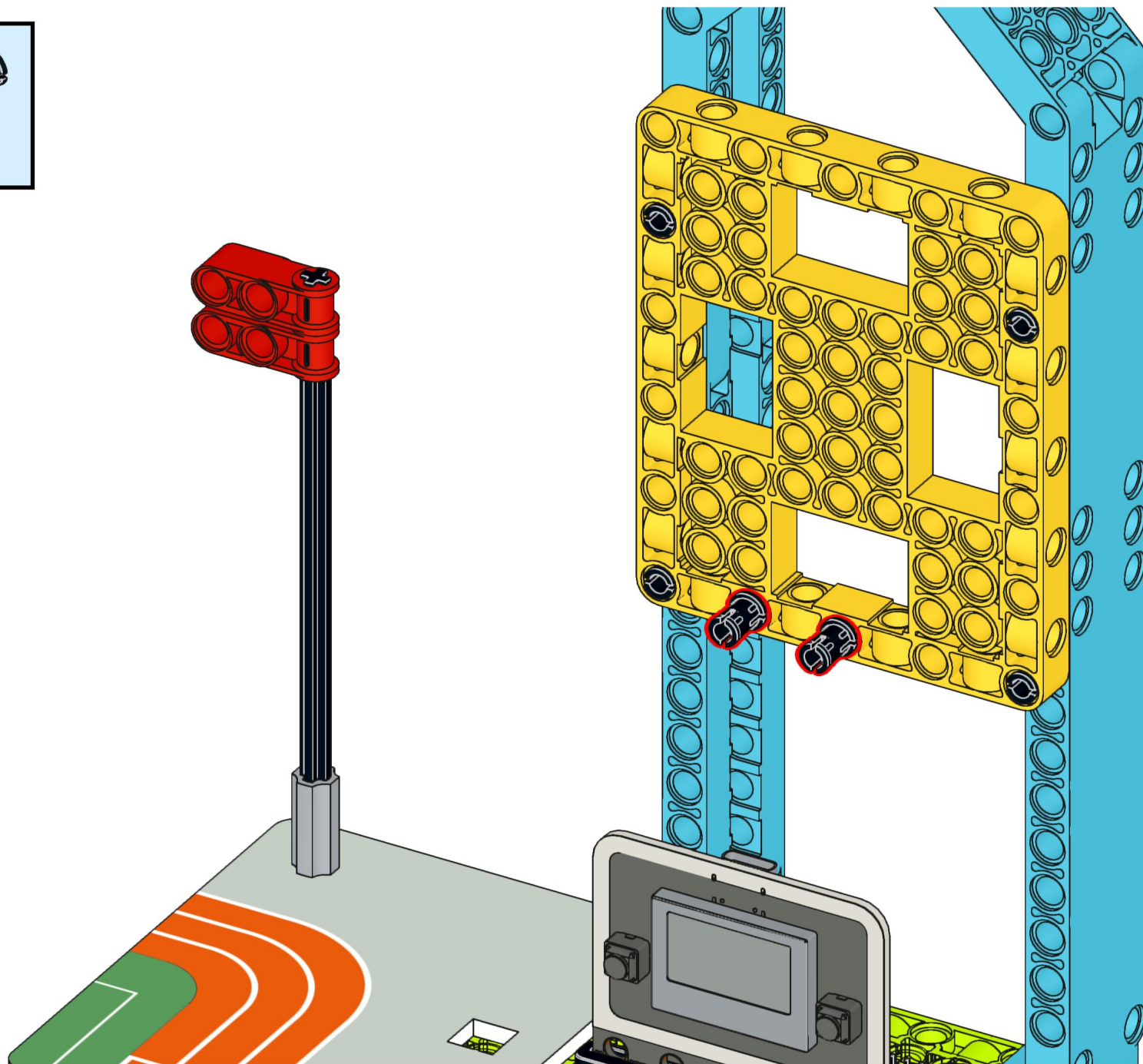
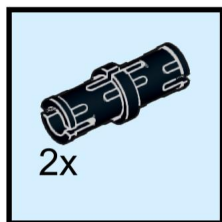

# 24

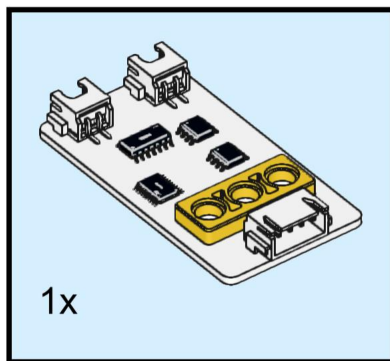

1x

语音合成模块

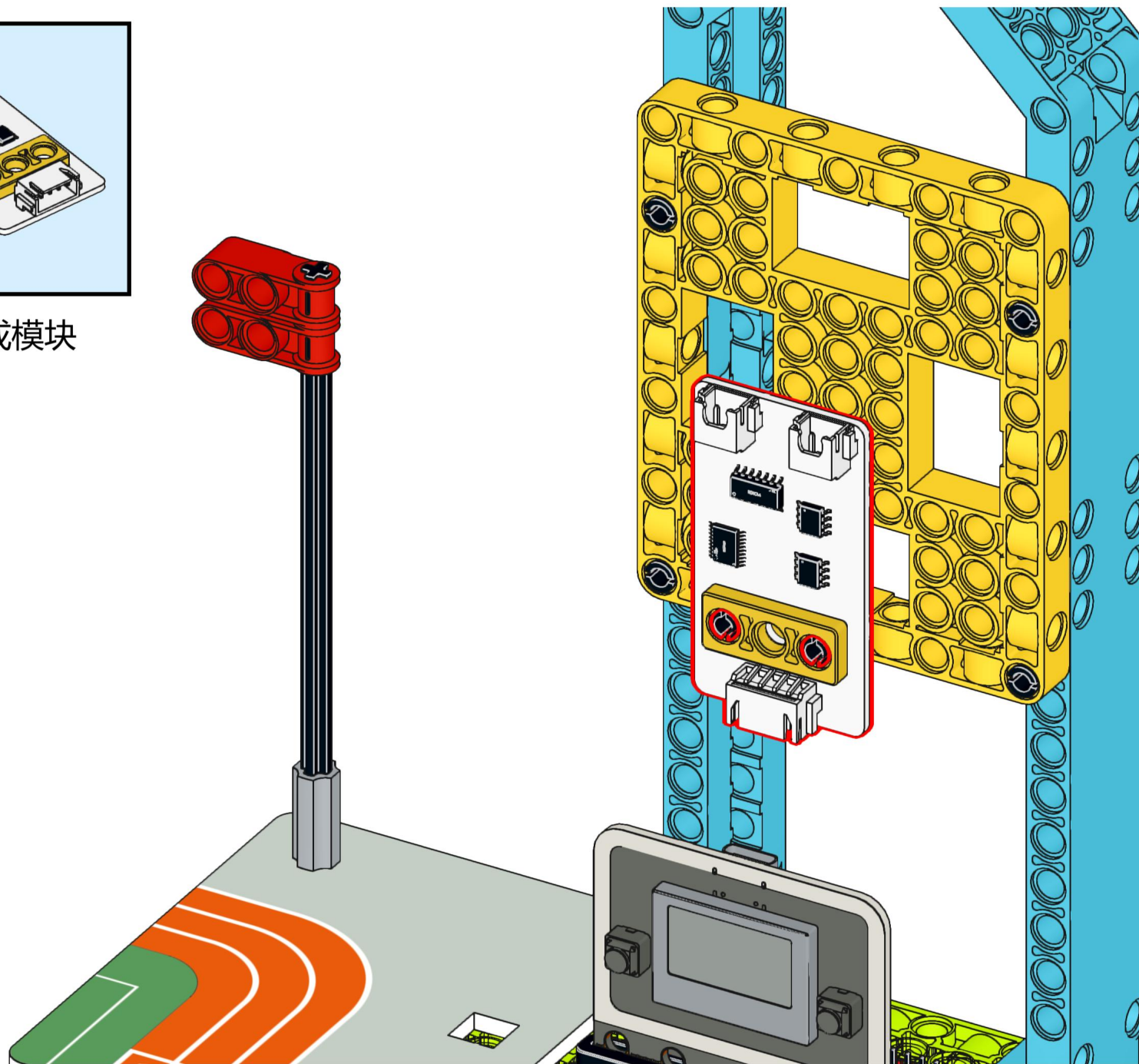

# 25

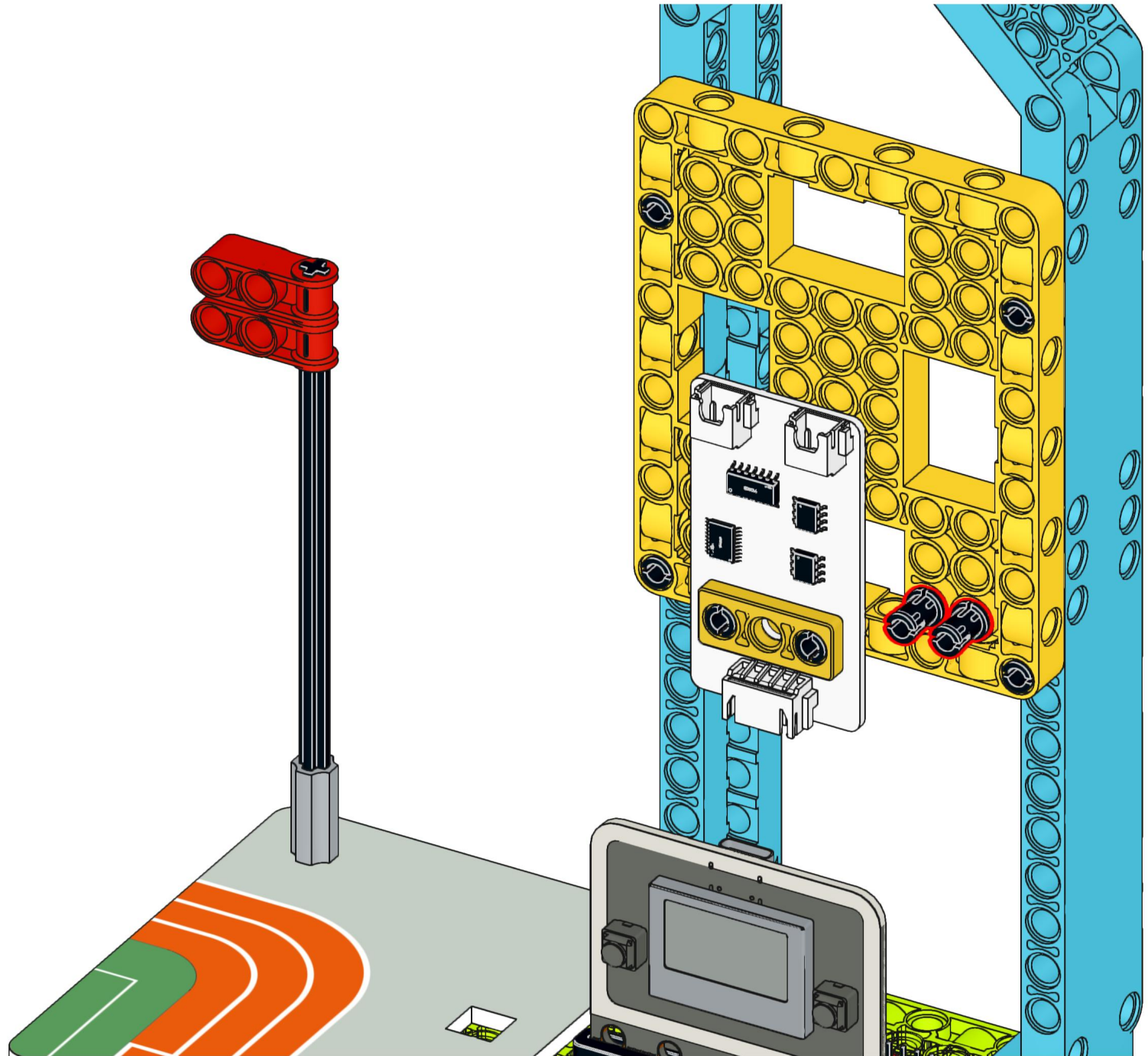
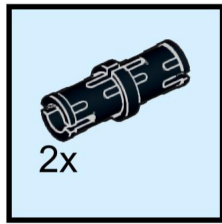

# 26

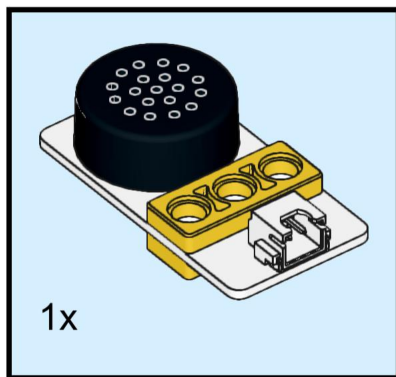

喇叭

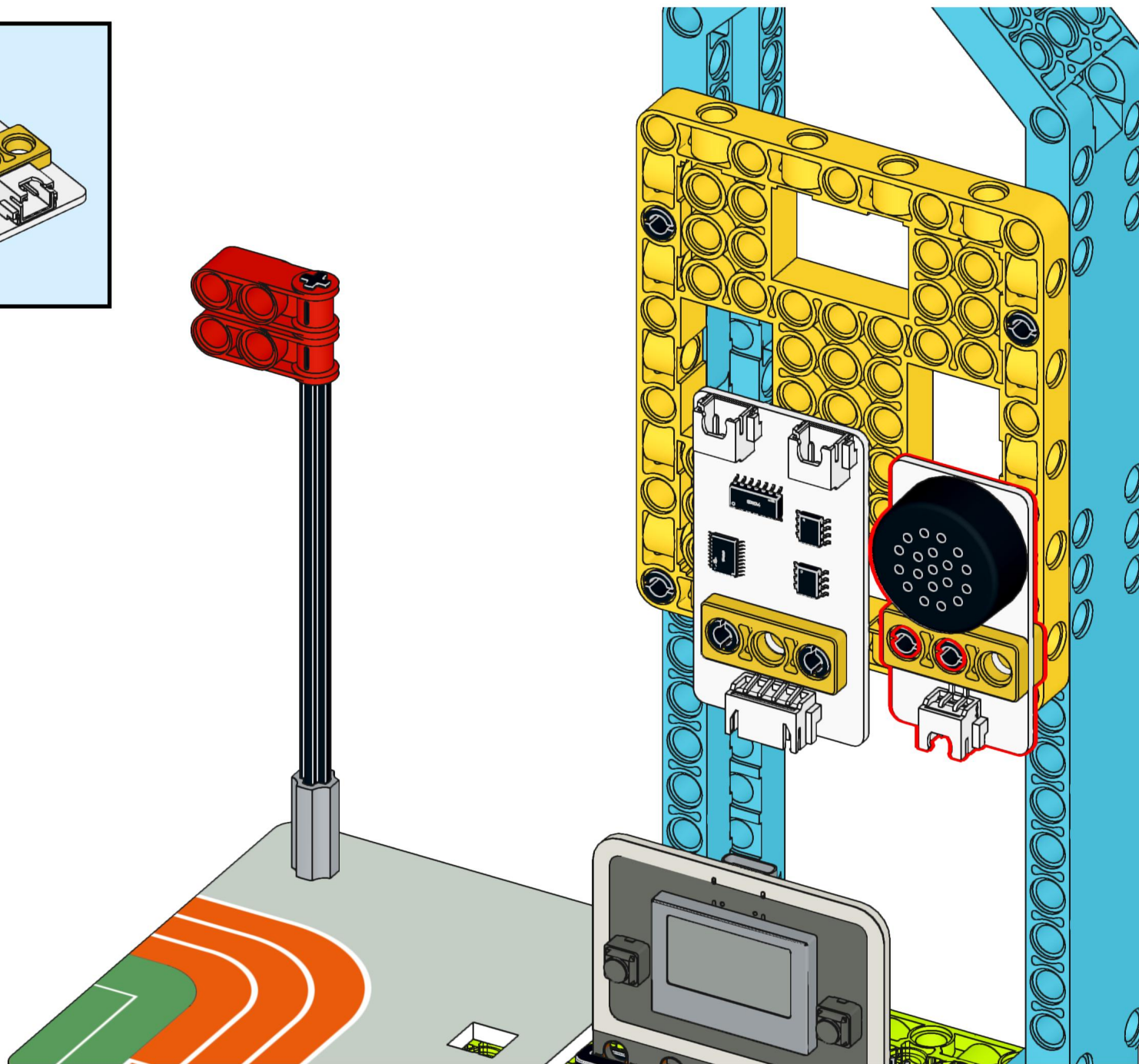

# 27

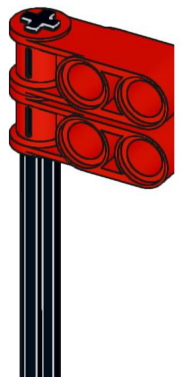
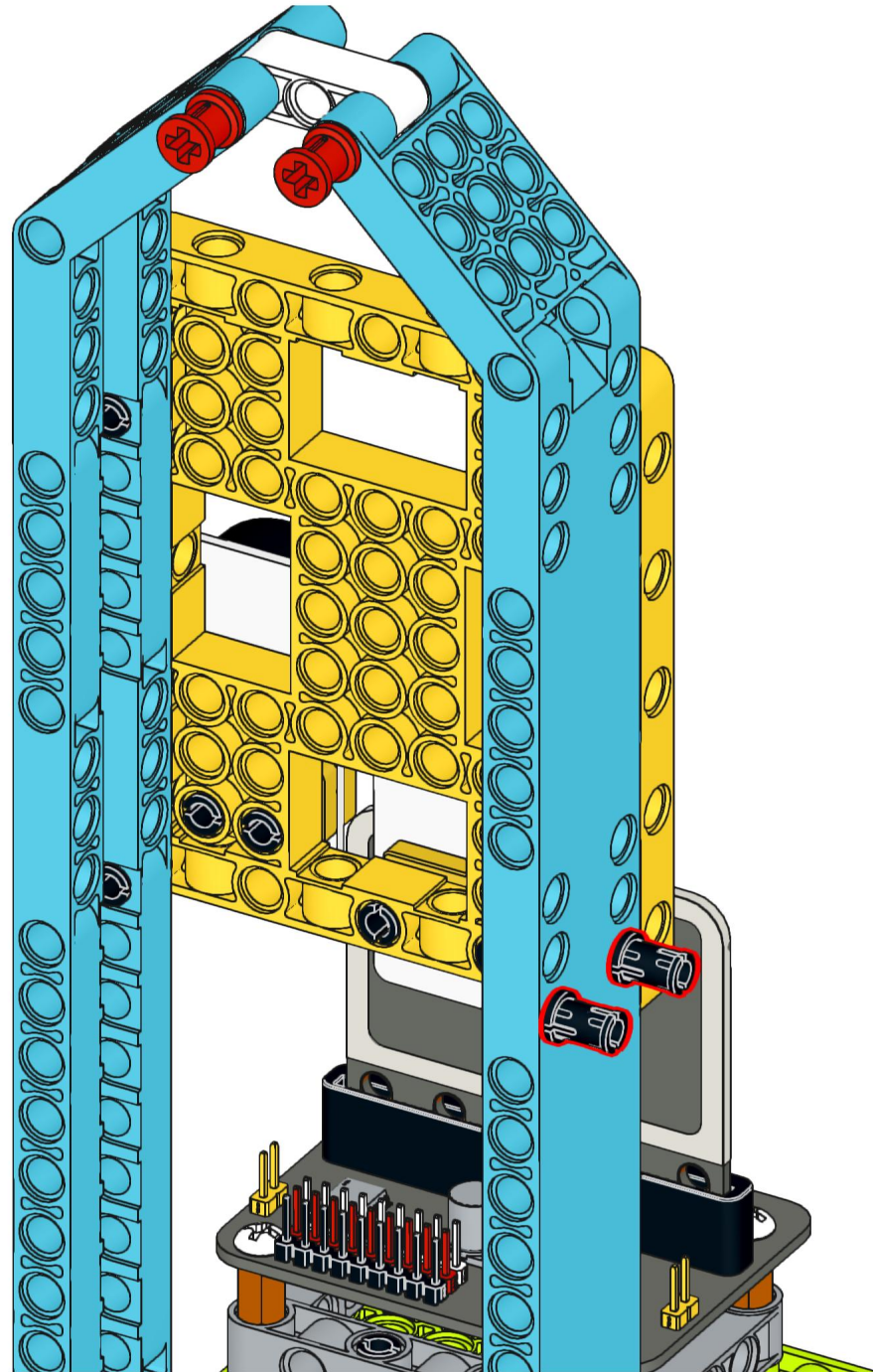
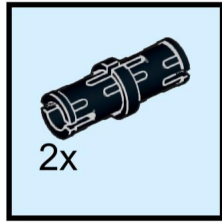

# 28

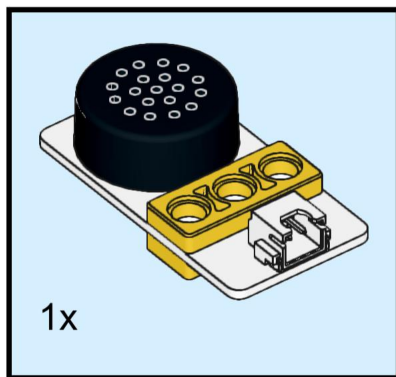

喇叭

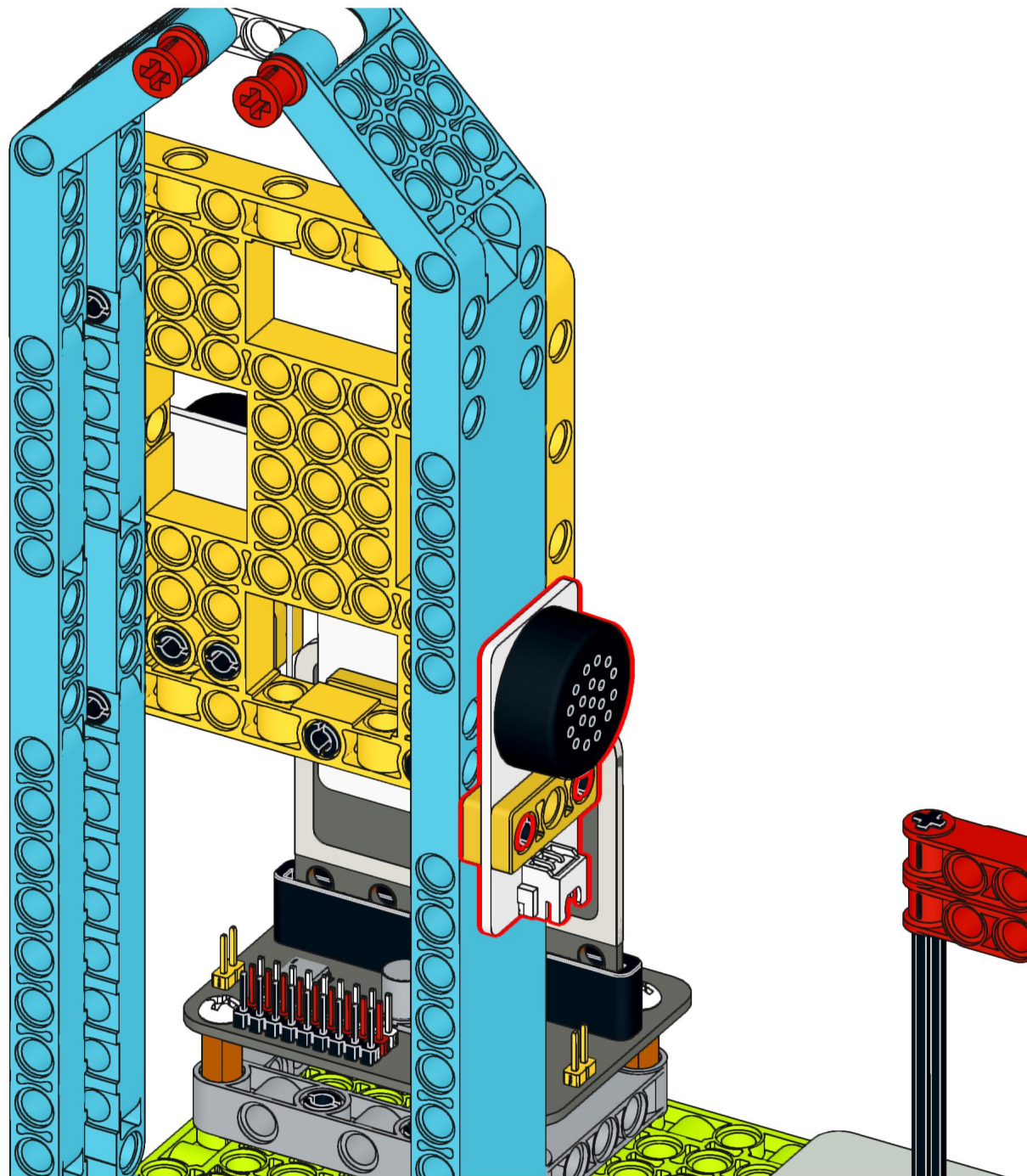

# 分区智能广播接线图

## 接线说明：

- 1、双路语音合成模块使用4P（I2C）线连接至扩展版任意I2C接口。其中，红线对应V引脚，黑线对应G引脚；
- 2、喇叭用2P适配线（短线）与双路语音合成模块相连；
- 3、1号喇叭安装在场景教学楼，2号喇叭安装在场景操场。

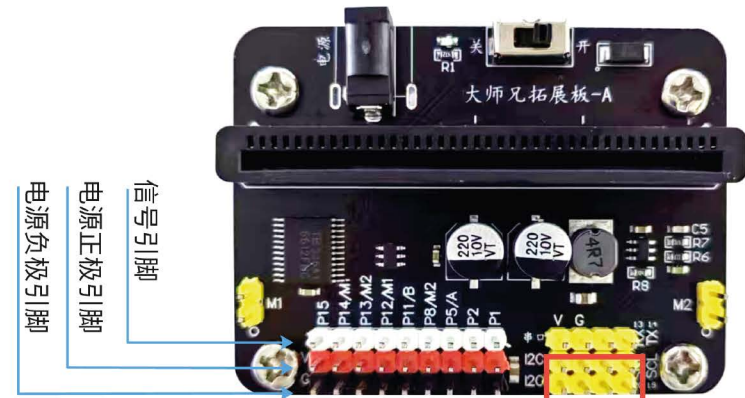

双路语音合成模块

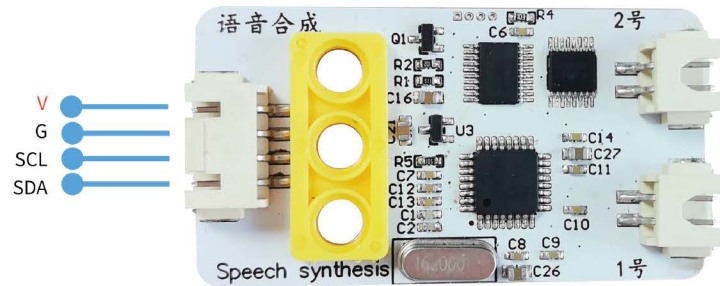

2号喇叭

1号喇叭



4P（IIC）适配线



2P适配线-20cm（双路语音合成 - 喇叭连接线）



2号喇叭

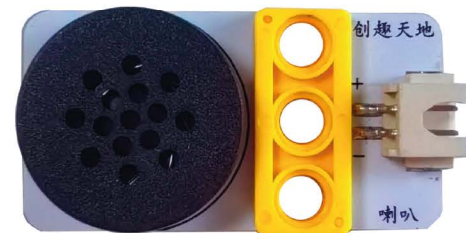

1号喇叭